

Do-more H2 Series PLC System Specifications

General Specifications

General Specifications	
Operating Temperature	32°F to 131°F (0°C to 55°C)
Storage Temperature	-4°F to 158°F (-20°C to 70°C)
Ambient Humidity	30% to 95% relative humidity (non-condensing)
Environmental Air	No corrosive gases
Vibration	MIL STD 810C, Method 514.2 IEC60068-2-6 JIS C60068-2-6 (Sine wave vibration test)
Shock	MIL STD 810C, Method 516.2 IEC60068-2-27 JIS C60068-2-27
Noise Immunity	NEMA ICS3-304
Agency Approvals	UL508 (File No. E157382, E316037) CE (EN61131-2)

CPU Modules

Specifications



H2-DM1 <--->



H2-DM1E <--->

Feature	H2-DM1	H2-DM1E
Total Memory (bytes)	262,144 bytes	
Ladder Memory (instruction words)	65,536 instruction words	
V-Memory (words)	Configurable up to 65536 (4096 default)	
Non-volatile V Memory (words)	Configurable up to 65536 (4096 default)	
D-memory (DWORDs)	Configurable up to 65536 (4096 default)	
Non-volatile D Memory (DWORDs)	Configurable up to 65536 (4096 default)	
R-memory (REAL DWORDs)	Configurable up to 65536 (4096 default)	
Non-volatile R Memory (REAL DWORDs)	Configurable up to 65536 (4096 default)	
Boolean execution/K	50 uSec	
Stage Programming	Yes	
Number of Stages	128 per Program code-block; number of code-blocks configurable to memory limit	
Handheld Programmer	No	
Programming Software for Windows	FREE Do-more Designer	
Built-In communications ports	USB, RS-232	USB, RS-232, Ethernet (10/100 Base-T)
Program Memory	Flash ROM	
Total I/O points available	X, Y, each configurable up to 65536 (2048 default); WX, WY (analog in/out) each configurable up to 65536 (256 default)	
Local I/O points available	256	
Ethernet Remote I/O Discrete points	131,072	
Ethernet Remote I/O Analog I/O Channels	32,768	
Max Number of Ethernet slaves per Channel	16	
I/O points per Remote Channel	32,768	
Discrete I/O Module Point Density	4/8/12/16/32	
Slots per Base	3/4/6/9	
Number of instructions available	>160	>170
Control relays	Configurable up to 65536 (2048 default)	
Special relays (system defined)	1024	
Special registers (system defined)	512	
Timers	Configurable up to 65536 (256 default)	
Counters	Configurable up to 65536 (256 default)	
System Date/Time structures	8	
User Date/Time structures	Configurable up to 65536 (32 default)	
ASCII String/Byte buffer structures	Configurable up to memory limit (192 default)	
Modbus Client memory	Yes, configurable up to memory limit, default 1024 input bits, 1024 coil bits, 2048 input registers, 2048 holding registers	
DL Classic Client memory	Up to memory limit, default 512 X, 512 Y, 512 C, 2048 V	
Immediate I/O	No	
Interrupt input (hardware / timed)	No	
Subroutines	Program and Task code-blocks, up to memory limit	
Drum Timers	Yes, up to memory limit	
Table Instructions	Yes	
Loops	FOR/NEXT, WHILE/WEND, REPEAT/UNTIL loops	
Math	>60 operators and functions: Integer, Floating Point, Trigonometric, Statistical, Logical, Bitwise, Timing	
ASCII	Yes, IN/OUT, Serial, Ethernet TCP and UDP; 11 output script commands	
PID Loop Control, Built In	Yes, configurable to memory limit (over 2,000)	
Time of Day Clock/Calendar	Yes	
Run Time Edits	Yes	
Supports True Force	Yes	
Internal Diagnostics	Yes	
Password security	Multi-user, credentialed, session-based security	
System error log	Yes	
User error log	Yes	
Battery backup	Yes (Battery included)	

CPU Modules

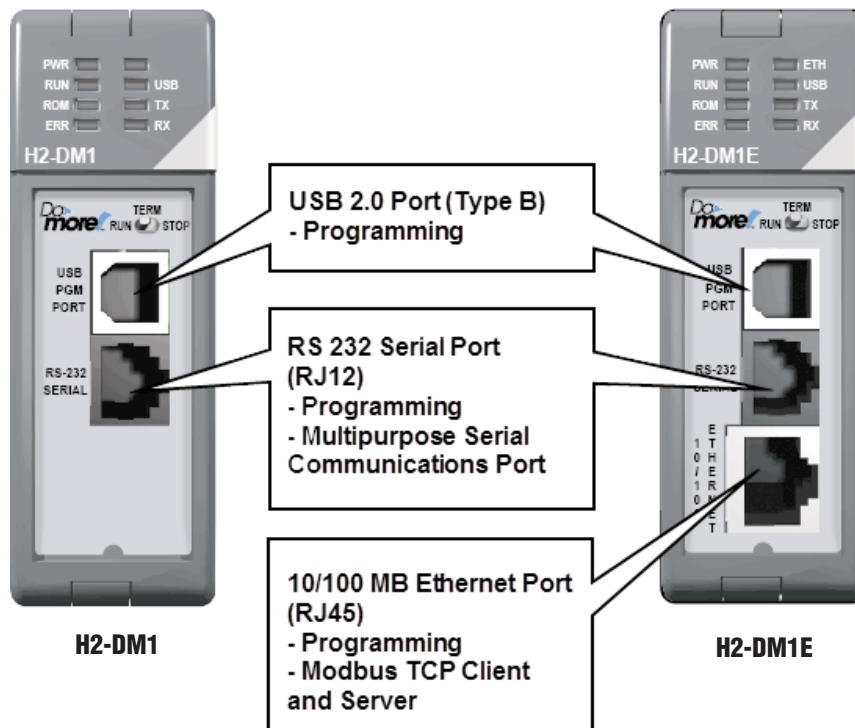

LED Status Indicators

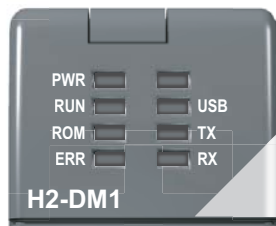

H2-DM1

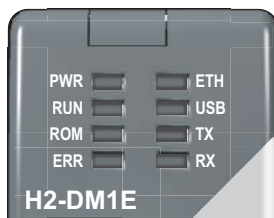

H2-DM1E

LED Indicators		
Indicator	Status	Description
PWR	Green	Base Power ON
	Yellow	Low Battery
RUN	Green	CPU is in RUN Mode
	Yellow	Forces are Active
ROM	Yellow	CPU is updating Non-volatile Memory
ERR	Red	CPU Fatal Error
ETH	Green	Ethernet Link Good
	Yellow	Ethernet Activity
USB	Green	USB Receive Activity
	Yellow	USB Transmit Activity
TX	Green	RS-232 Transmit Activity
RX	Green	RS-232 Receive Activity

PLC Mode Switch



Mode Switch Functions	
Mode Switch Position	CPU Action
RUN (Run Program)	CPU is forced into RUN Mode if no errors are encountered.
TERM (Terminal)	RUN, PROGRAM and DEBUG modes are available. In this mode, the mode of operation can be changed through the Programming Software.
STOP (Stop Program)	CPU is forced into STOP Mode.

CPU Modules

Communication Ports

USB Port

Used exclusively for programming and monitoring via a PC running Do-more Designer.

USB Port Specifications	
Description	Standard USB 2.0 Slave input for programming and online monitoring, with built-in surge protection. Not compatible with older full speed USB devices.
Cables (ADC part #)	USB Type A to USB Type B: USB-CBL-AB3 (3 ft.) USB-CBL-AB6 (6 ft.) USB-CBL-AB10 (10 ft.) USB-CBL-AB15 (15 ft.)

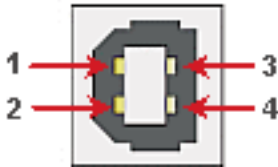

Pin	Description	
1	5V	Bus Voltage Sense
2	D-	Data -
3	D+	Data +
4	0V	Ground

RS-232 Port

RJ-12 style connector used for:

- Connection to a PC running Do-more Designer
- Modbus RTU Master connections
- Modbus RTU Slave connections
- ASCII Incoming and Outgoing communications
- Custom Protocol Incoming and Outgoing communications

RS-232 Port Specifications	
Description	Non-isolated, full duplex RS-232 DTE port used for programming, online monitoring or can connect the CPU as a Modbus RTU or ASCII master or slave to a peripheral device. Includes ESD and built-in surge protection.
Baud Rates	1200, 2400, 4800, 9600, 19200, 38400, 57600, and 115200
+5V Cable Power Source	220 mA maximum at 5V, +/- 5%. Reverse polarity and overload protected.
Maximum Output Load (TXD/RTS)	3 K Ω , 1,000 pf
Minimum Output Voltage Swing	+/-5V
Output Short Circuit Protection	+/-15 mA
Cable Options (ADC part #)	D2-DSCBL FA-CABKIT FA-ISOCAN for converting RS-232 to isolated RS-422/485

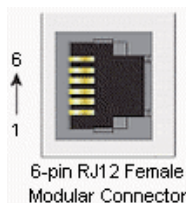

Pin	Description	
1	0V	Power (-) connection (GND)
2	5V	Power (+) connection (220 mA max.)
3	RXD	Receive Data (RS-232)
4	TXD	Transmit Data (RS-232)
5	RTS	Request to Send (RS-232)
6	CTS	Clear to Send (RS-232)

For a list of protocols supported by each port, please refer to the Communications topic of the Do-more H2 Series PLC Overview in this section.

CPU Modules

Ethernet Port

RJ-45 style connector used for:

- Connection to a PC running Do-more Designer
- Modbus TCP Client connections (Modbus requests sent from the CPU)
- Modbus TCP Server connections (Modbus requests received by the CPU)

Ethernet Port Specifications	
Description	Standard transformer isolated Ethernet port with built-in surge protection for programming, online monitoring and Modbus/TCP client/server connections (fixed IP or DHCP).
Transfer Rate	10/100 Mbps
Cables	Use a Patch (straight through) cable when a switch or hub is used. Use a Crossover cable when a switch or hub is not used.

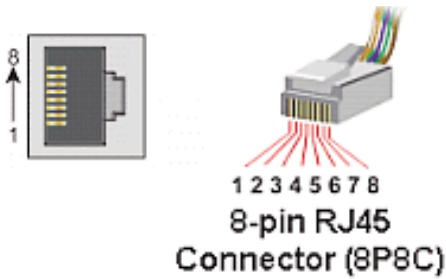

Patch (Straight-through) Cable

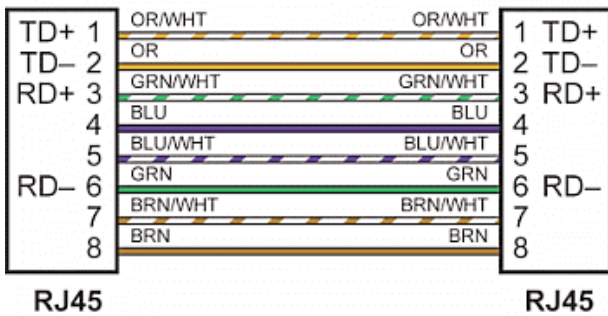

Crossover Cable

10/BASE-T/100BASE-TX

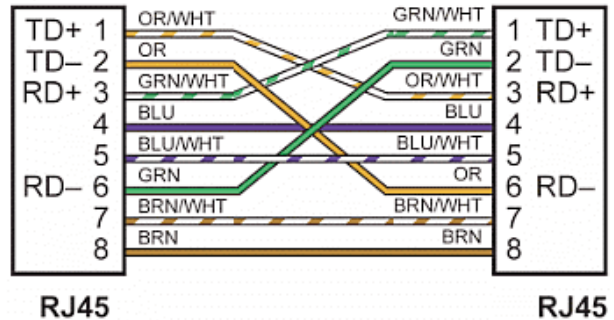

For a list of protocols supported by each port, please refer to the Communications topic of the Do-more H2 Series PLC Overview in this section.

Battery Specifications

A battery is included with the Do-more CPU and is used to retain the Time and Date along with any Tagname values that are set up as retentive. It is recommended that the battery be replaced once every five years or when one year of cumulative OFF time has been exceeded.

Up to two hours is allowed to change out a battery without loss of data.

Battery

D0-MC-BAT	Coin type, 3.0V Lithium battery, number CR2032
-----------	--

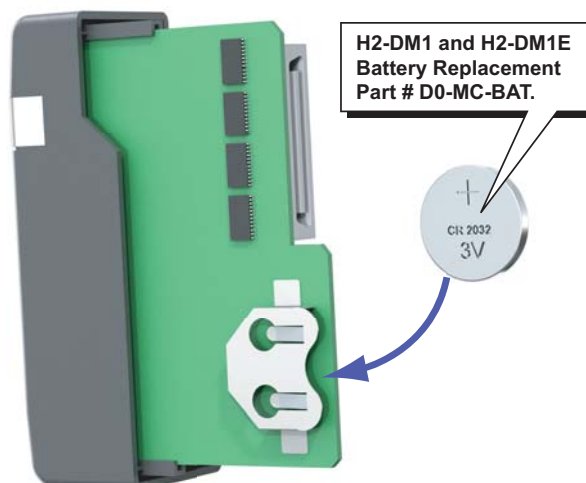

Do-more H2 Series PLC Overview

Do-more Designer (Part No. DM-PGMSW)

Do-more Designer is the full-featured programming software for the Do-more PLC series. Do-more Designer is a free download from Automationdirect.com. A CD-ROM version is also available for purchase.



Start Page

When the software is started, the Start Page is displayed. This page contains a Launchpad with Projects, Applications and Links windows. It also contains shortcuts to important help file topics and the Do-more Simulator.

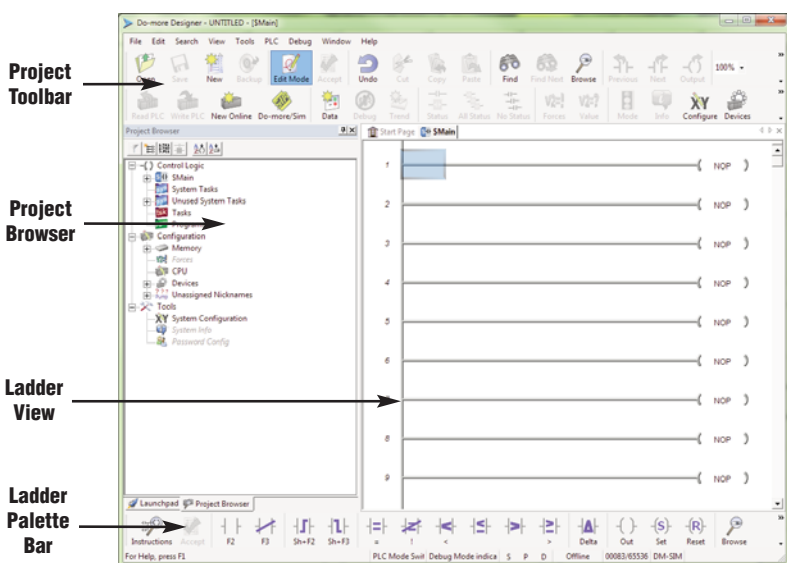
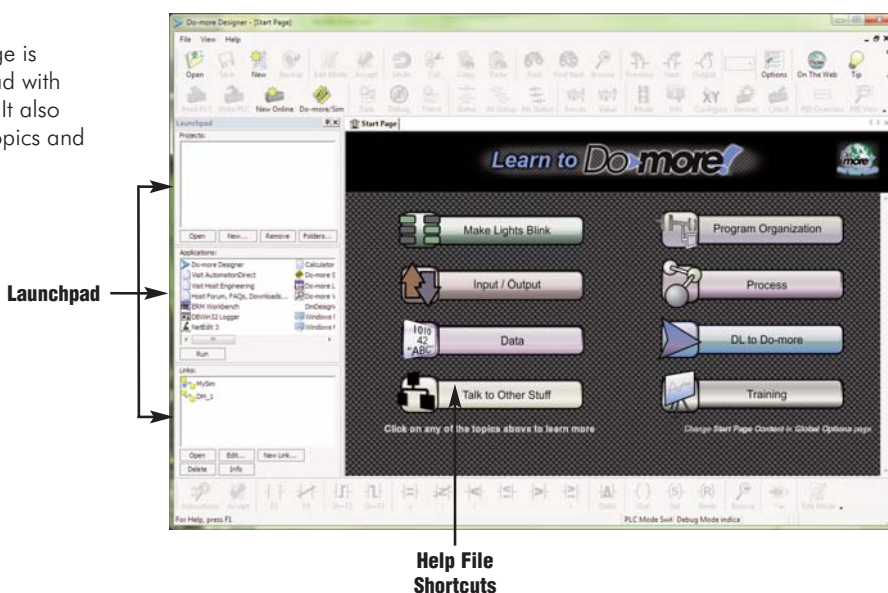

Main Programming Window

The Main Programming Window is displayed when a new program is started or an existing program is opened. It is divided into Menu, Toolbars, and Windows that work together to make project development as simple as possible.