

Autonics

**PULSE METER
MP5W SERIES**

M A N U A L



Thank you very much for selecting Autonics products.
For your safety, please read the following before using.

Caution for your safety

- ※Please keep these instructions and review them before using this unit.
- ※Please observe the cautions that follow;
- Warning** Serious injury may result if instructions are not followed.
- Caution** Product may be damaged, or injury may result if instructions are not followed.
- ※The following is an explanation of the symbols used in the operation manual.
- ⚠caution: Injury or danger may occur under special conditions.

Warning

- In case of using this unit with machineries(Nuclear power control, medical equipment, vehicle, train, airplane, combustion apparatus, entertainment or safety device etc), it requires installing fail-safe device, or contact us for information on type required.**
It may result in serious damage, fire or human injury.
- It must be mounted on panel.**
It may give an electric shock.
- Do not repair or check up when power on.**
It may give an electric shock.
- Do not disassemble and modify this unit, when it requires. If needs, please contact us.**
It may give an electric shock and cause a fire.
- Please check the number of terminal when connect power line or measuring input.**
It may cause a fire.

Caution

- This unit shall not be used outdoors.**
It might shorten the life cycle of the product or give an electric shock.
- When wire connection for power input and measuring input, the tightening strength for screw bolt on terminal block should be over than 0.74N · m ~ 0.90N · m.**
It may result in malfunction or fire due to contact failure.
- Please observe specification rating.**
It might shorten the life cycle of the product and cause a fire.
- Do not use the load beyond rated switching capacity of Relay contact.**
It may cause insulation failure, contact melt, contact failure, relay broken, fire etc.
- In cleaning the unit, do not use water or an oil-based detergent.**
It might cause an electric shock or fire that will result in damage to this product.
- Do not use this unit at place where there are flammable or explosive gas, humidity, direct ray the sun, radiant heat, vibration, impact etc.**
It may cause a fire or explosion.
- Do not inflow dust or wire dregs into inside of this unit.**
It may cause a fire or mechanical trouble.
- Please connect properly after checking the polarity of measuring terminals.**
It may cause a fire or explosion.

※The above specification are changeable without notice anytime.

Ordering information

①Series	MP	Pulse meter
②Digit	5	5Digit(99999)
③Size	W	DIN Size W96 × H48mm
④Power supply	4	100-240VAC 50/60Hz
⑤Output (Main output +Sub output)		
Symbol	Main output(Comparative value output)	Sub output(Display value output)
N	Indication type only	X
A	Relay five-stage(HH, H, GO, L, LL)	X
1	Relay three-stage(H, GO, L)	X
2	NPN open collector five-stage output	BCD Dynamic output
3	PNP open collector five-stage output	BCD Dynamic output
4	NPN open collector five-stage output	PV retransmission(4-20mADC) output
5	PNP open collector five-stage output	PV retransmission(4-20mADC) output
6	NPN open collector five-stage output	Low speed serial output
7	PNP open collector five-stage output	Low speed serial output
8	NPN open collector five-stage output	RS485 communication output
9	PNP open collector five-stage output	RS485 communication output

※PNP open collector output:Option

Specifications

Model	MP5W
Power supply	100-240VAC 50/60Hz
Allowable voltage range	90 to 110% of rated voltage
Power consumption	Approx. Max. 6VA
Power for external sensor	12VDC ±10%, 80mA
Measuring accuracy (23 ±5°C)	<ul style="list-style-type: none"> Mode F1, F4, F7, F8, F9, F10 : F.S. ±0.05% rdg ±1Digit Mode F2, F3, F5, F6 : F.S. ±0.01% rdg ±1Digit
Measuring range	<ul style="list-style-type: none"> Mode F1, F4, F7, F8, F9, F10 : 0.0005Hz to 50kHz Mode F3 : 0.02s to 3,200s Mode F2, F5, F6 : 0.01s to 3,200s Mode F11, F12, F13 : 0 to 4 × 10⁹ Count
Input frequency	<ul style="list-style-type: none"> Solid state input : Max. 50kHz(Pulse width:Min. 10μs) Contact input : Max. 45Hz(Pulse width:Min. 11ms)
Input level	[Voltage input] High : 4.5-24VDC, Low : 0-1VDC, Input impedance : 4.5kΩ [No-voltage input] Short-circuit impedance : Max. 300Ω, Residual voltage : Max. 1V, Open-circuit impedance : Min. 100kΩ
Max. indication	5digit(-19999 to 99999)
Display method	7 Segment LED(Zero Blanking)
Display accuracy	0.05 / 0.5 / 1 / 2 / 4 / 8sec.(The same as update output cycle)
Operation mode	Number of revolution/Speed/Frequency(F1), Passing speed(F2), Cycle(F3), Passing time(F4), Time width(F5), Time difference(F6), Absolute rate(F7), Error ratio(F8), Density(F9), Error(F10), Length measurement(F11), Interval(F12), Integration(F13)
Prescale function	Direct input method(0.0001 × 10 ⁻⁹ to 9.9999 × 10 ⁹)
Hysteresis	0 to 9999
Other functions	<ul style="list-style-type: none"> Lock setting function Auto-Zero time setting function Monitoring delay function Monitoring function : Memorize max. value or min. value Current output range selection(Current output type only) Remote/Local switching function(Communication output type only) Comparative output function(HH, H, GO, L, LL) Data Bank switching function Time unit selection function Memory retention function(Mode F13 applied only) Deviation memory function(F output mode applied only) ※Please see the last page for the detail.
Output form	<ul style="list-style-type: none"> Relay contact output(Three-stage output:3a)(Five-stage output:5a contact):Comparative output, Alarm output Transistor output(NPN/PNP open collector) Comparative output, Alarm output Low speed serial output:Display value output BCD Dynamic output:Display value output PV retransmission output(4-20mADC):Display value output RS485 communication output(32 channel) Display value output, Comparative output, PC setting function
Memory	Non-volatile memory(Input times : 100,000 times)
Insulation resistance	Min. 100MΩ(Standard 500VDC) between terminal and case
Dielectric strength	2000VAC 60Hz 1minute(Between terminals of AC power and case, Between terminals of AC power and measuring terminals)
Impulse noise strength	±2000V the square wave noise(pulse width:1μs) by the noise simulator
Vibration	Mechanical 0.75mm amplitude at frequency of 10 to 55Hz in each of X, Y, Z directions for 2 hour Malfunction 0.5mm amplitude at frequency of 10 to 55Hz in each of X, Y, Z directions for 10 minutes
Shock	Mechanical 300m/s ² (Approx. 30G) 3 times at X, Y, Z direction Malfunction 100m/s ² (Approx. 10G) 3 times at X, Y, Z direction
Relay life cycle	Min.10,000,000 times
Electrical life cycle	Min.100,000 times(250VAC 3A resistive load)
Ambient temperature	-10 to 50°C(at non-freezing status)[]
Storage temperature	-20 to 60°C(at non-freezing status)[]
Ambient humidity	35 to 85%RH
Weight	Approx. 230g

Dimensions

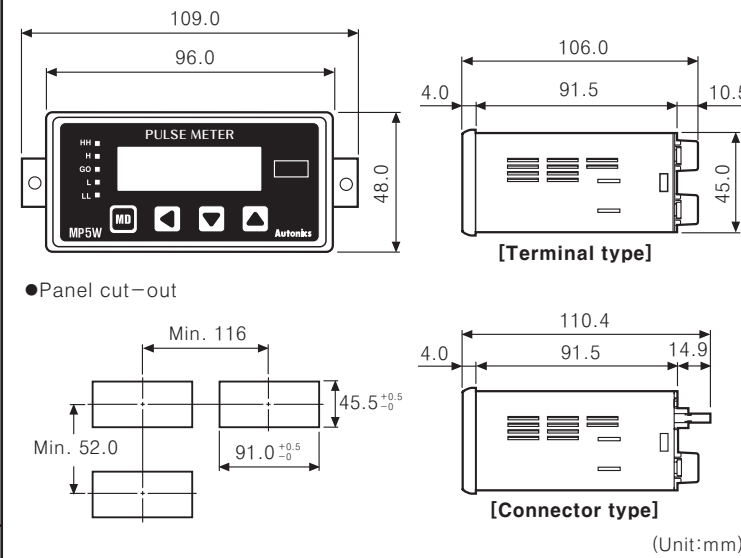

Connections

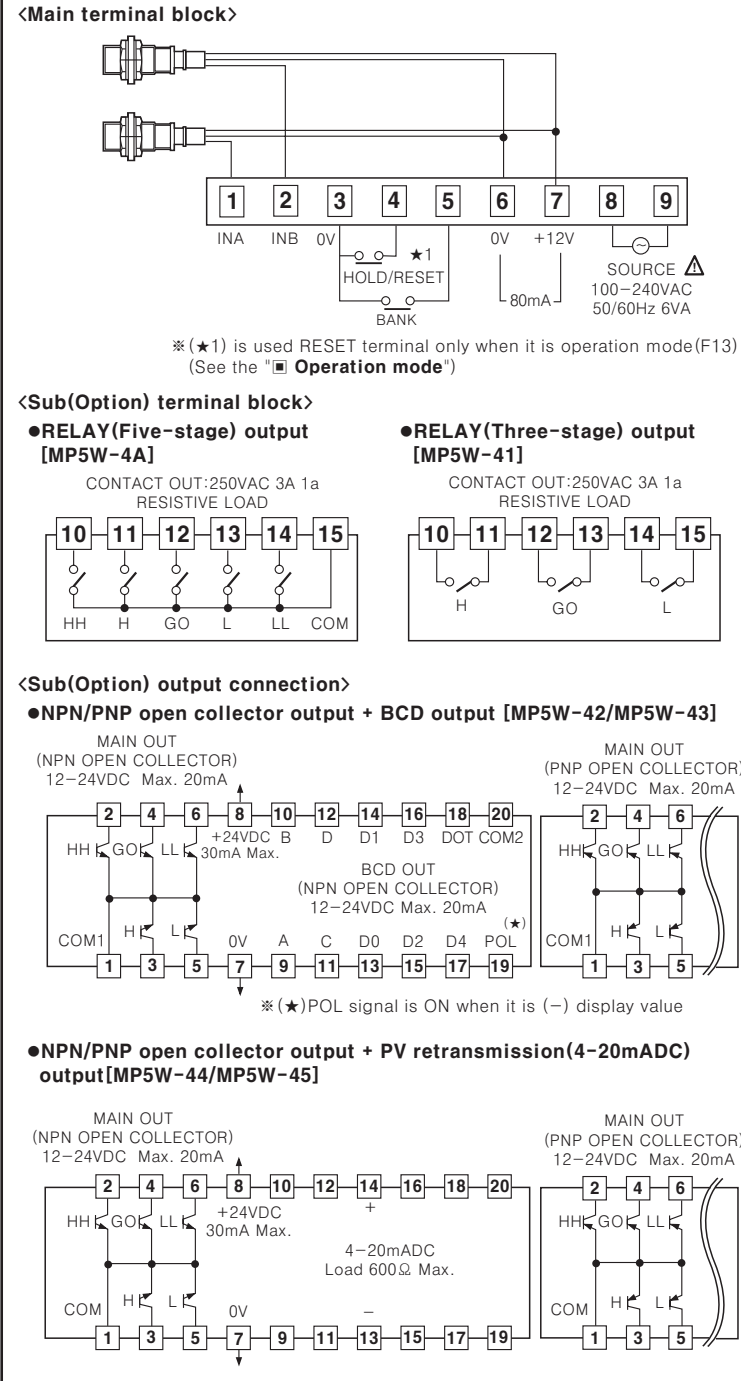

NPN/PNP open collector output + Low speed serial output [MP5W-46/MP5W-47]

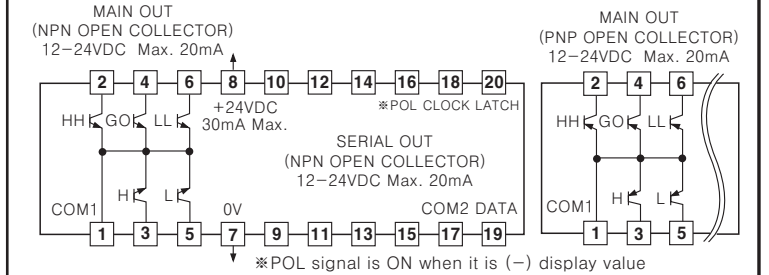

NPN /PNP open collector output + RS485 communication output [MP5W-48/MP5W-49]

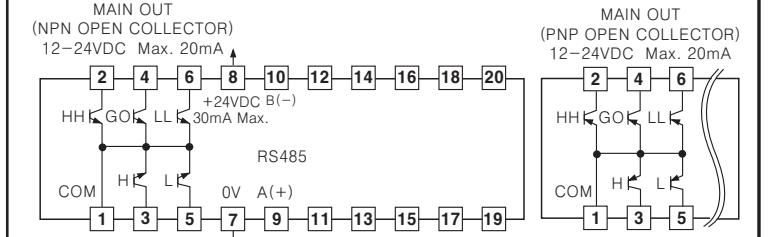

Input · Output

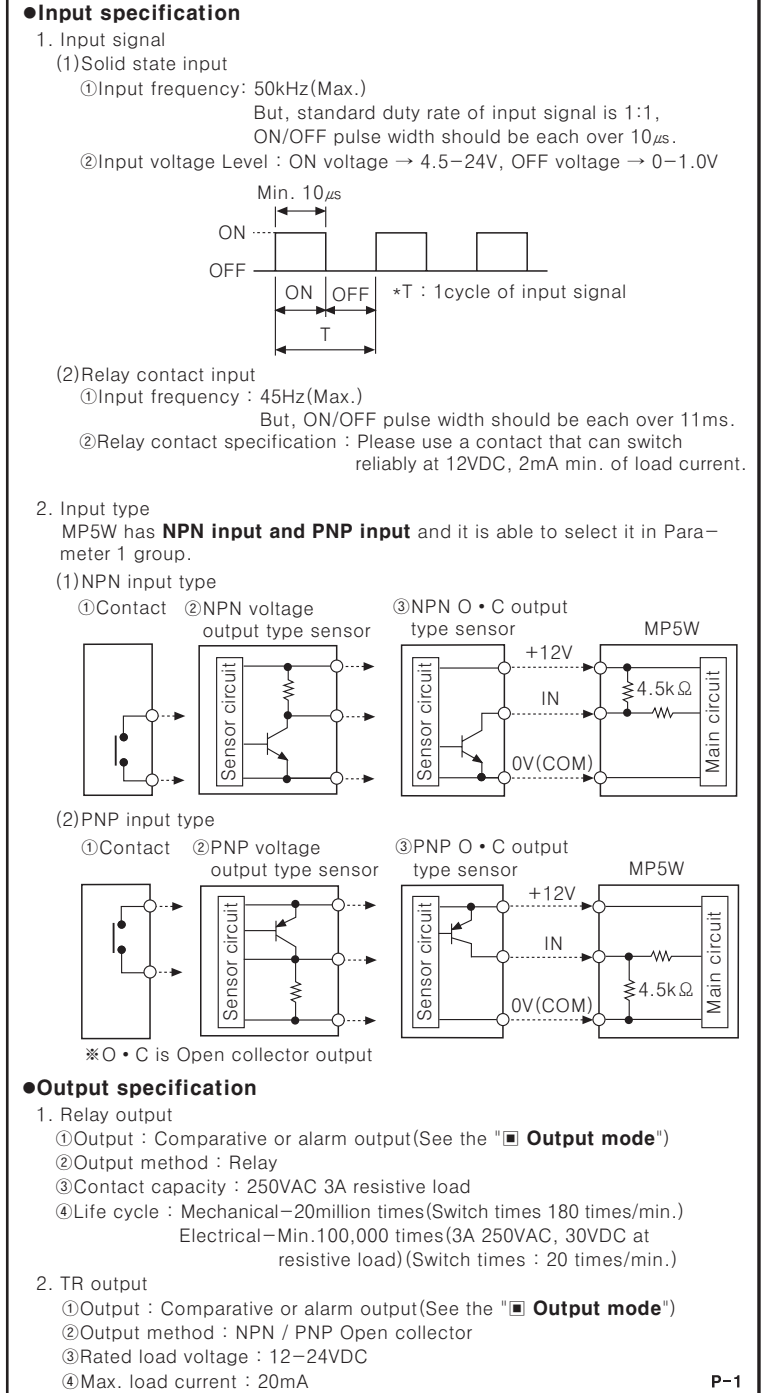

3. BCD Dynamic output
- Output : Display value
 - Output signal : BCD Data(A, B, C, D) ← A : Lowest bit, D : Highest bit
Digit Data(D0, D1, D2, D3, D4) ← D0 : Lowest digit, D4 : Highest digit
 - Output type : NPN Open Collector
 - Rated load voltage : 12-24VDC
 - Max. load current : 20mA
- Ex) When display value is 125.89

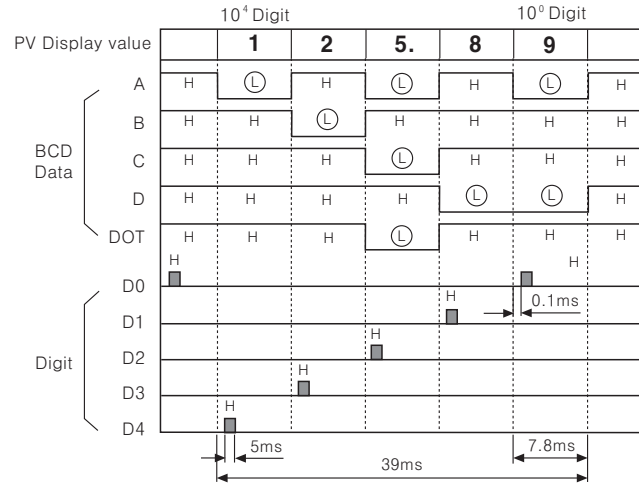

4. Low speed serial output
- Output : Display value
 - Output signal : CLK, Data, Latch
 - CLK cycle : 50Hz
 - Output CLK bit : 25 bit
 - Output Data bit : 25 bit
 - Output form: NPN Open Collector
 - Rated load voltage : 12-24VDC
 - Max. load current : 20mA

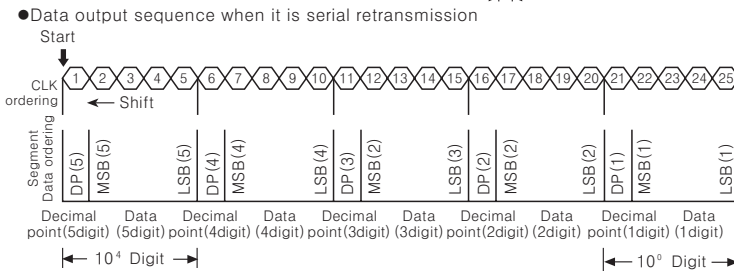
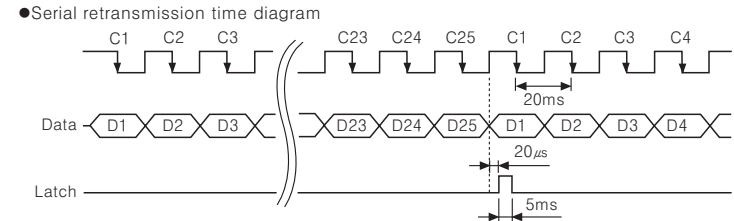

5. PV retransmission output(4-20mADC)
- Application : To transmit the measured value
 - Function :
- This function is to transmit 4-20mADC converted from measured display value between High limit output(FS-H) and Low limit(FS-L).
- Range of High/Low limit output setting
 - High limit setting range(FS-H): From min. to max within range of measurement
 - Low limit setting range(FS-L): From min. to max within range of measurement (FS-H should be over "1" bigger than FS-L)
 - Resistive load : Max. 600Ω
 - Resolution : 8000 division

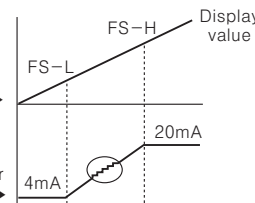

6. RS485 communication output
- Address : 0 ~ 99 address(32 channel)
 - Retransmission speed(Baud rate) : 2400/4800/9600 bps
 - Retransmission code : ASCII
 - Parity Bit : No
 - Data Bit : 8 Bit
 - Stop Bit : 1 Bit
 - Communication items
 - MP5W ← PC : Comparative value of each bank data, Prescale value and Peak value, RESET control
 - MP5W → PC : Comparative value of each bank data, Prescale value and Peak value, Display value

Operation mode

- Select operation mode from **mode**(mode) of Parameter 1 group.
- There are 13 kinds of operation mode in this unit.

- **Mode F1(Frequency/Number of revolution/Speed)**
- This mode is to display calculated frequency or number of revolution, speed by measuring frequency of Input A,
- Frequency(Hz) = $f \times \alpha$ ($\alpha = 1[\text{sec}]$)
 - Number of revolution(rpm) = $f \times \alpha$ ($\alpha = 60[\text{sec}]$)
 - Speed(m/min) = $f \times \alpha$ ($\alpha = 60L[\text{sec}]$)
- * L = The length of conveyor moved for 1 pulse cycle[m]

Display value	Display unit	α (Prescale value)
Frequency	Hz	1
	kHz	0.001
Number of revolution	rps	1
	rpm	60
Speed	mm / sec	1,000L
	cm / sec	100L
	m / sec	L
	m / min	60L
	km / hour	3.6L

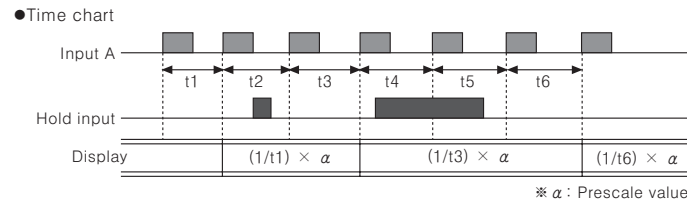

- **Mode F2(Passing speed)**
- It displays the passing speed between ON of input A and ON of input B.
- Passing speed(V) = $f \times \alpha$ ($\alpha = L[\text{m}]$)
- * f : This is reciprocal number of the time between ON of input A and ON of input B
L : The distance between input A and input B[m]

Display value	Display unit	α (Prescale value)
Passing speed	mm / sec	1,000L
	cm / sec	100L
	m / sec	L
	m / min	60L
	km / hour	3.6L

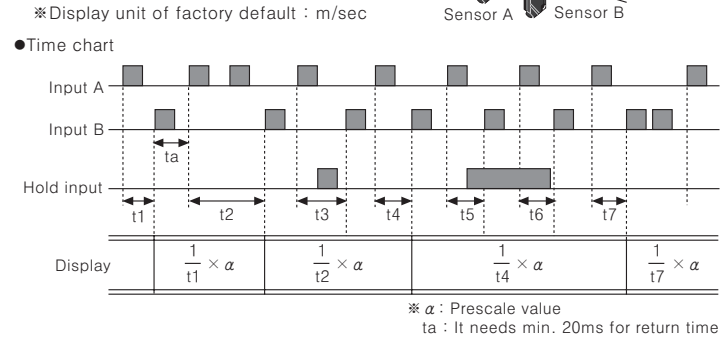

- **Mode F3(Cycle)**
- It displays the time from when input A is ON to the next ON of input A.
- Cycle(T) = t
- * t : Measurement time[sec]

Display value	Display unit	SEC	MIN
Cycle		999.99sec.	999.99min.
		9999.9sec.	9999.9min.
		99min.	99hour 99min.
		59.9sec.	59.9min.
		9hour 59min. 59sec.	999hour 59min. 59sec.
		99999sec.	99999min.

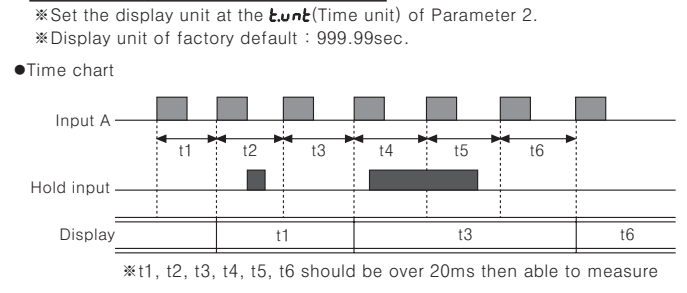

- **Mode F4(Passing time)**
- It displays the passing time of certain distance as measuring the time between ON and the next ON of Input A.
- Passing time[sec] = $t \times \alpha$ ($\alpha = \frac{L[\text{m}]}{\text{Moving distance within 1pulse cycle}[\text{m}]}$)

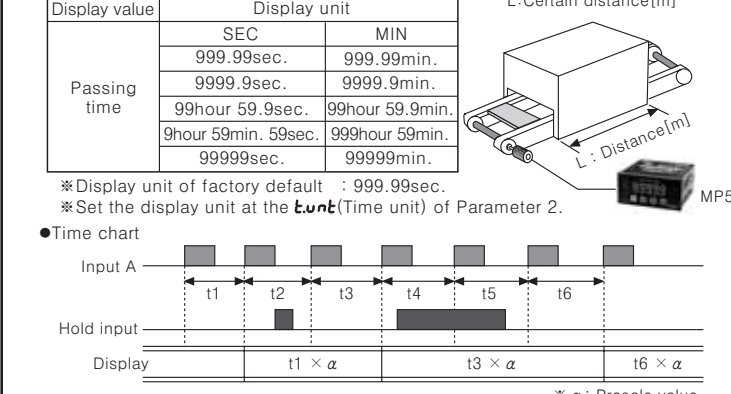

- **Mode F5(Time width)**
- It displays the ON time of input A.
- Time width[T] = t
- * t : ON measurement time of input A[sec]

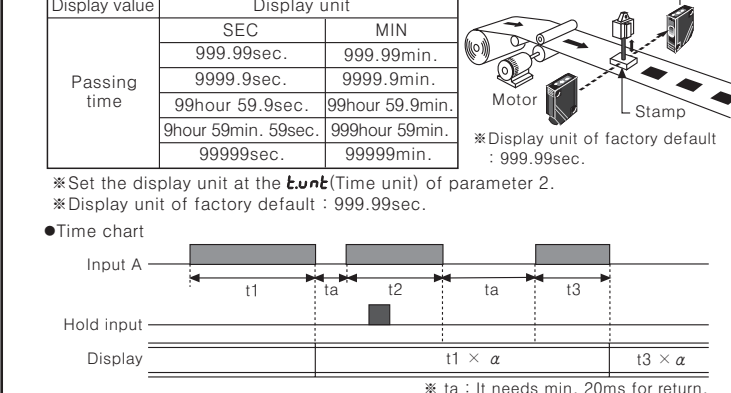

- **Mode F6(Time interval)**
- It displays the time from input A is ON to input B is ON.
- Time difference(T) = $t(ta \text{ to } tb)$
- * t(ta to tb): The measurement time from input A is ON to input B is ON[sec]

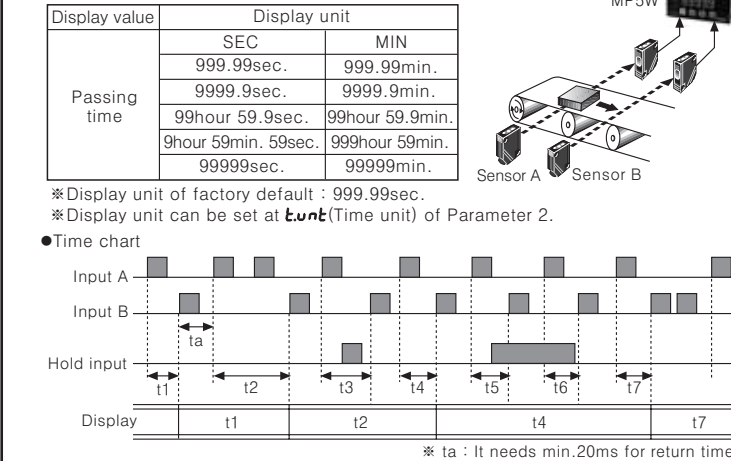

- **Mode F7(Absolute rate)**
- It displays how many percentage(%) faster or late, speed, volume etc. of Input B against input A
- Absolute rate = $(\text{Input B} / \text{Input A}) \times 100\%$
- Absolute rate = $\frac{\text{Frequency of input B}[\text{Hz}] \times B\alpha}{\text{Frequency of input A}[\text{Hz}] \times A\alpha} \times 100\%$

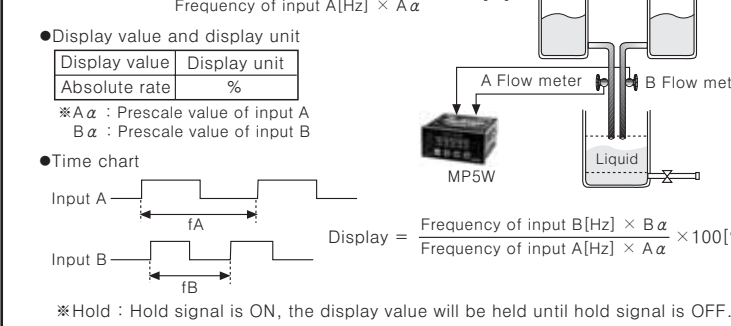

- **Mode F8(Error ratio)**
- It displays how many percentage(%) faster or late of Input B against Input A.
- Absolute rate = $\frac{\text{Input B} - \text{Input A}}{\text{Input A}} \times 100\%$
- Error rate = $\frac{(\text{Frequency of input B}[\text{Hz}] \times B\alpha) - (\text{Frequency of input A}[\text{Hz}] \times A\alpha)}{\text{Frequency of input A}[\text{Hz}] \times A\alpha} \times 100\%$

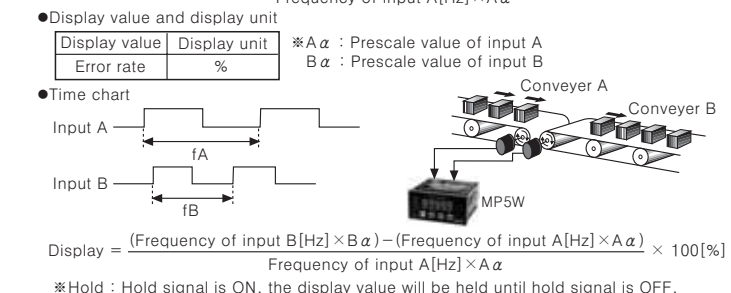

- **Mode F9(Density)**
- It displays the density rate of input B against total sum of input A and input B.
- Density = $\frac{\text{Input B}}{\text{Input A} + \text{Input B}} \times 100\%$
- Density = $\frac{\text{Frequency of input B}[\text{Hz}] \times B\alpha}{(\text{Frequency of input A}[\text{Hz}] \times A\alpha) + (\text{Frequency of input B}[\text{Hz}] \times B\alpha)} \times 100\%$

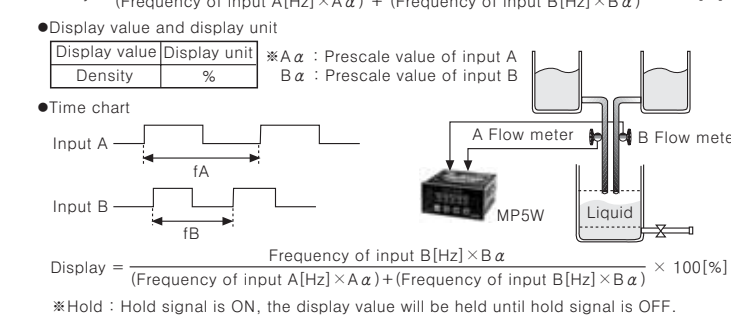

- **Mode F10(Error)**
- It displays the error between standard Input A and comparing Input B.
- Error = Input B - Input A
- Error = $(\text{Frequency of input B}[\text{Hz}] \times B\alpha) - (\text{Frequency of input A}[\text{Hz}] \times A\alpha)$

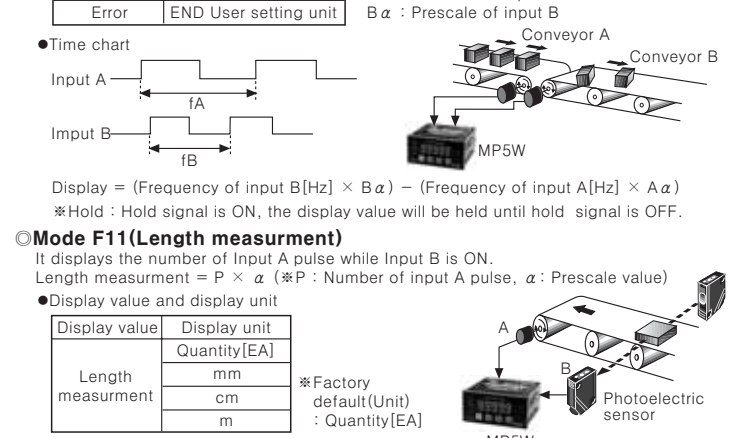

- **Mode F11(Length measurement)**
- It displays the number of Input A pulse while Input B is ON.
- Length measurement = $P \times \alpha$ (* P : Number of input A pulse, α : Prescale value)

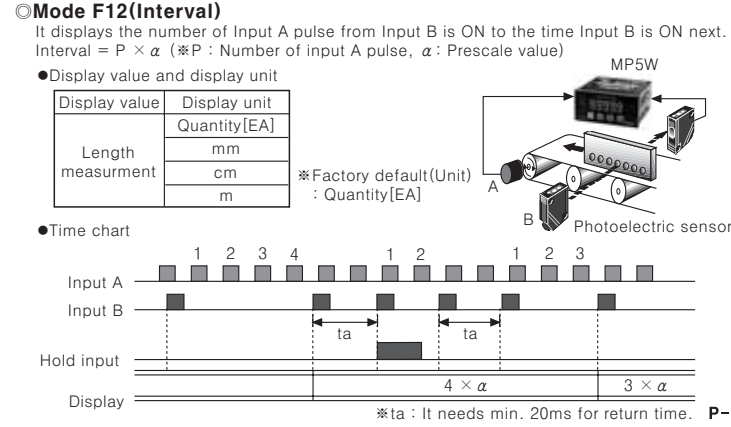

Mode F13(Integration)

It displays the counting value against pulses of Input A. Integration = P x alpha

*P: Pulse number of input A, alpha: Prescale value

Display value and display unit

Table with columns: Display value, Display unit, Interval, Quantity[EA]

Operation and Time chart

It counts the number of input A pulse. As input B is an enable input signal it stops the counting and display value of input A when it is ON and then it counts input A continuously when it is OFF.

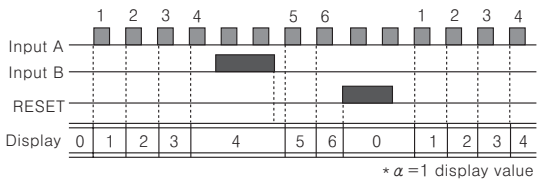

Output mode

- Select output mode in out-t(output type) of Parameter1 group. There are 5 stages output(HH, H, GO, L, LL) and 3 stage output(H, GO, L). There are 6 kinds of output mode such as S(Standard) output mode, H(High) output mode, L(Low) output mode, B(Block) output mode, I(One shot) output mode, F(Deviation) output mode. The setting value(HH, H, L, LL) should be LL<L<H<HH in B comparative output type and it operates individually not related to the setting value(HH, H, L, LL) in others output(S, H, L, I).

S(Standard) output mode[StAr.d]

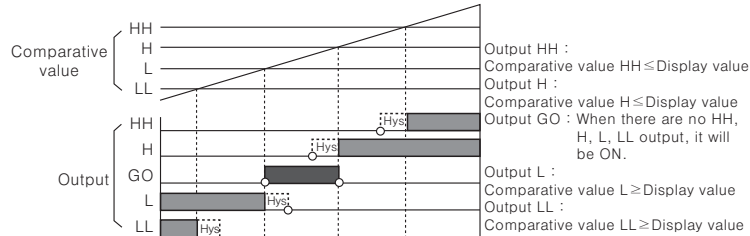

H(High) output mode[out-h]

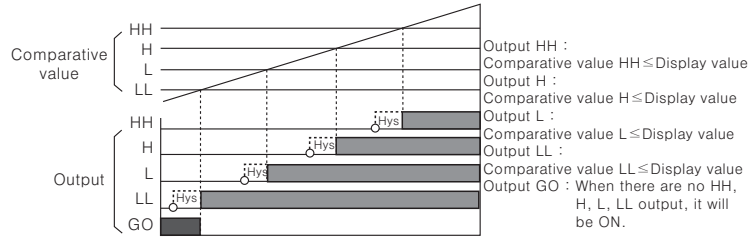

L(Low) output mode[out-L]

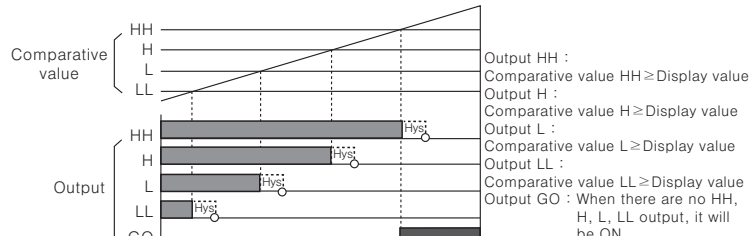

B(Block) output mode[out-b]

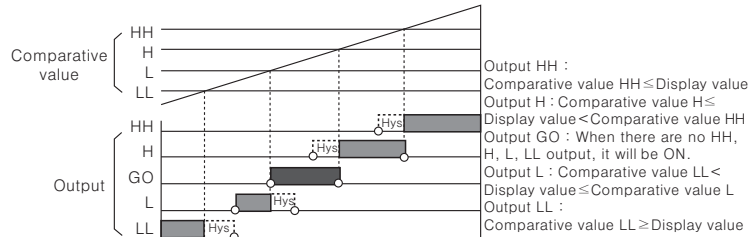

I(One Shot) output mode[out-I]

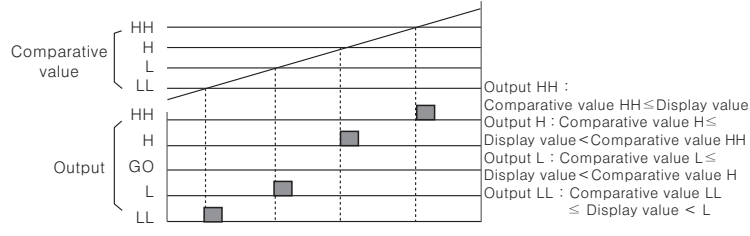

*There is no GO output in output I mode. *One Shot(One Shot) output time has been fixed 0.3sec. *There is no Hysteresis in I(One shot) comparative output mode.

F(Deflection) output mode[out-F]

This function is to memorize the setting value and provide outputs when it exceeds the deviation of H, L.

The setting value memory: Memorize the current display value as the setting value by pressing (M+MD) key in front.

Display the setting value: Check the memorized the setting value by (MD) key. (Display the memorized setting value for pressing MD key continuously.)

Deviation setting: Set H, L deviation by setting value. (The set deviation will be memorized until set the next deviation again when power off.)

Deviation setting range: 0.0001 to 99999(The setting range will be changed by decimal point setting parameter. If set decimal point as 0000.0, the setting range will be 0.1 to 9999.9.)

Operation: Press (M+MD) Key at the same time for memorizing the setting value

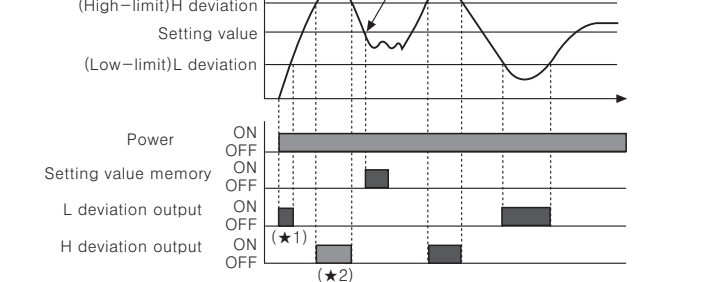

(High-limit)H deviation, (Low-limit)L deviation, Power ON/OFF, Setting value memory, L deviation output, H deviation output

*(*1)When select the comparative output limit function, output will not be come. *(2)Output position may different from above graph as output coming under assuming the setting value memory is before the setting value memory point on above graph. *There are no HH, GO, LL outputs in F output mode. *Even thought you set the deviation as "0(Zero)", it will actually work as setting "1".

Operation chart by each Parameter group

The display parameter are different by each operation mode, please see "Parameter".

When select the operation mode, the parameter will be displayed. X: When select the operation mode, the parameter will not be displayed.

Parameter 0 group

Table for Parameter 0 group showing available parameters across modes F1-F13.

Parameter 1 group

Table for Parameter 1 group showing available parameters across modes F1-F13.

Parameter 2 group

Table for Parameter 2 group showing available parameters across modes F1-F13.

Parameter 3 group

Table for Parameter 3 group showing available parameters across modes F1-F13.

Note: PSC. x are displayed in mode F1, F2, F4, F11, F12, F13.

Monitoring delay function operation chart by each output mode

Table showing monitoring delay function settings for different output modes.

Parameter

Parameter 0 group

Table for Parameter 0 group with columns: Menu and Parameter display, Parameter, Setting range, Setting key.

*(*1)If you press MD key in RUN mode, it will enter into PSt.hh(F output mode:PSt.h) at comparative output mode and h.PEK at indication type. *When entering into parameter 0, the parameter and data will be flickering by 1 sec. then moving the setting digit and changing the setting value are available. *It will show the set data to flicker by 1sec., then move to next Parameter with touching MD key once.

Parameter 1 group

Table for Parameter 1 group with columns: Menu and Parameter display, Parameter, Setting range, Setting key.

*If press MD key for 3 sec. in RUN, it will enter into parameter 1 group. *(1)It will not be displayed in indication type. The output mode is fixed as out-h type in F13 operation mode. *(2)Hysteresis operation mode is able to be set in F1, F7 to F10 operation mode. *(3)You are able to select the comparative output limit function or starting correction [StAr.t] timer in monitoring delay function mode. When selecting the comparative output limit[F.dEFy] function, it will move to the next parameter [Auto.A] and when selecting the starting correction timer[StAr.t] you need to be set the starting correction time[0.0 ~ 999.9] so that it moves to the next parameter [Auto.A]. *If press MD key for over 2 sec. in every setting mode, data will be set and return to RUN. *When entering into parameter 1 group, the parameter name and data will be flickering by 1 sec. then move setting digit by MD key or change the setting value by MD key. *All data set by users will be shown[displayed] to 1sec. cycle then move to the next parameter by pressing MD key.

