

# VFD C2000



#### IABU Headquarters

Delta Electronics, Inc.  
Taoyuan1  
31-1, Xingbang Road, Guishan Industrial Zone,  
Taoyuan County 33370, Taiwan, R.O.C.  
TEL: 886-3-362-6301 / FAX: 886-3-362-7267

#### Asia

Delta Electronics (Jiang Su) Ltd.  
Wujiang Plant3  
1688 Jiangxing East Road,  
Wujiang Economy Development Zone,  
Wujiang City, Jiang Su Province,  
People's Republic of China (Post code: 215200)  
TEL: 86-512-6340-3008 / FAX: 86-512-6340-7290

Delta Greentech (China) Co., Ltd.  
238 Min-Xia Road, Cao-Lu Industry Zone, Pudong, Shanghai,  
People's Republic of China  
Post code : 201209  
TEL: 021-58635678 / FAX: 021-58630003

Delta Electronics (Japan), Inc.  
Tokyo Office  
Delta Shibadaimon Building, 2-1-14  
Shibadaimon, Minato-Ku, Tokyo, 105-0012,  
Japan  
TEL: 81-3-5733-1111 / FAX: 81-3-5733-1211

Delta Power Solutions (India) Pte. Ltd.  
Plot No. 28, Sector-34, EHTP  
Gurgaon-122001 Haryana, India  
TEL: 91-124-416-9040 / FAX: 91-124-403-6045

#### America

Delta Products Corporation (USA)  
Raleigh Office  
P.O. Box 12173, 5101 Davis Drive,  
Research Triangle Park, NC 27709, U.S.A.  
TEL: 1-919-767-3813 / FAX: 1-919-767-3969

Delta Products Corporation (Brazil)  
Sao Paulo Office  
Rua Itapeva, N° 26, 3° andar, Bela vista  
ZIP: 01332-000 - São Paulo - SP - Brasil  
TEL : 55-11-3568-3875 / FAX : 55-11-3568-3865

#### Europe

Deltronics (The Netherlands) B.V.  
Eindhoven Office  
De Witbogt 15, 5652 AG Eindhoven, The Netherlands  
TEL: 31-40-2592850 / FAX: 31-40-2592851

107392, .7, .309  
/ : (495) 661-24-41  
E-mail: sales@deltronics.ru  
http://www.deltronics.ru



Delta Electronics -

- VFD-C2000.  
(FOC),

- 
- 
- 
- 
- 
- 
- 
- 

CE, UL cUL



# C2000

VFD-C

FOC-

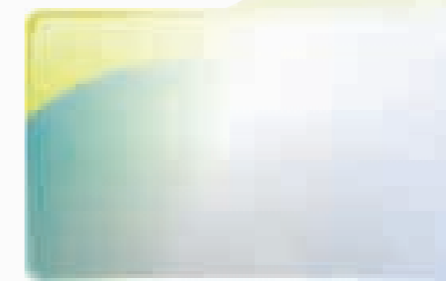

■ (SVC),



■ VFD-C2000 (EN954-1, EN60204-1 IEC61508),

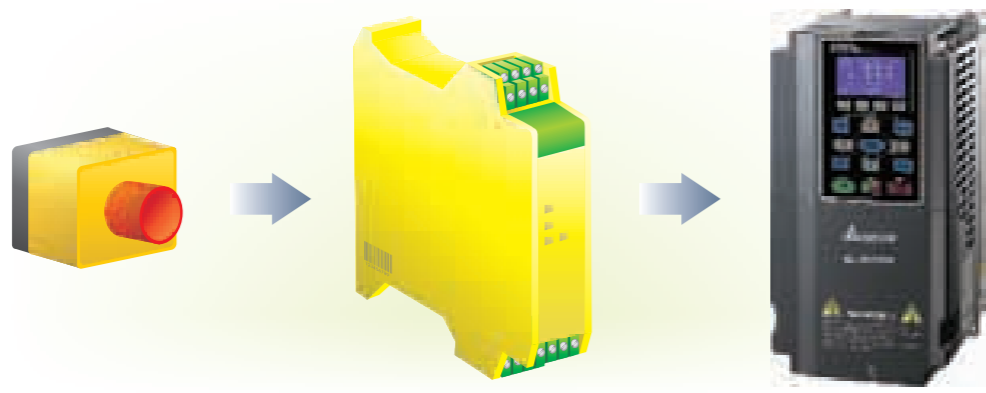

■ FOC-

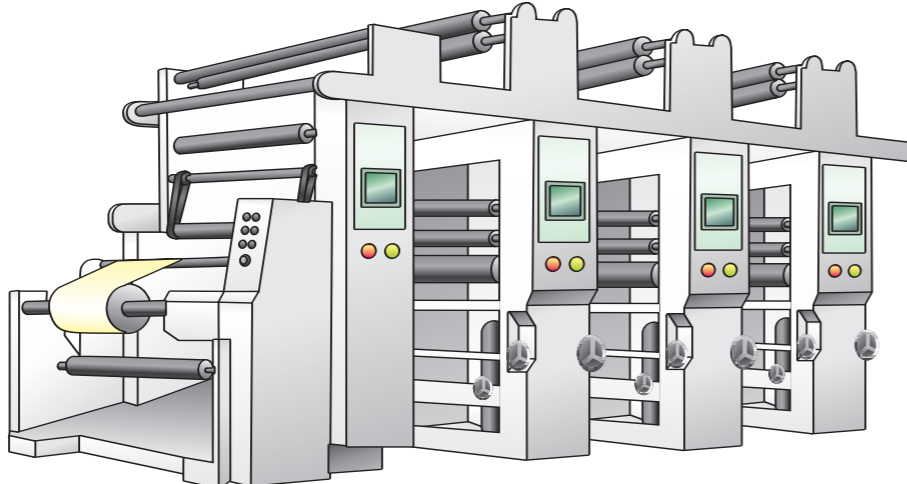

■ FOC- , 200%

FOC+PG

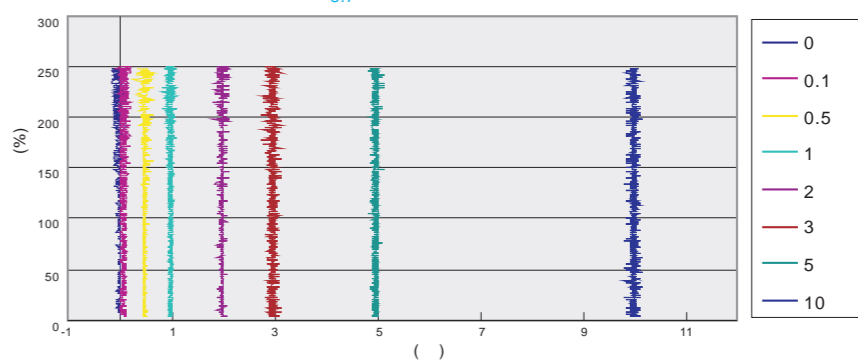

■ VFD-C2000

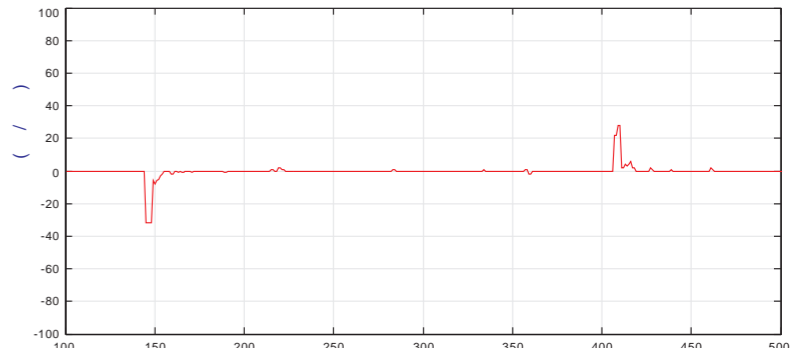
■ VFD-C PDFF-



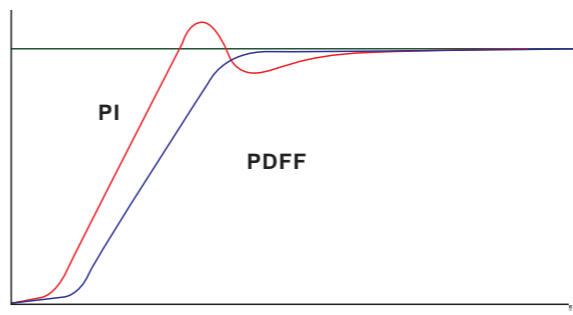
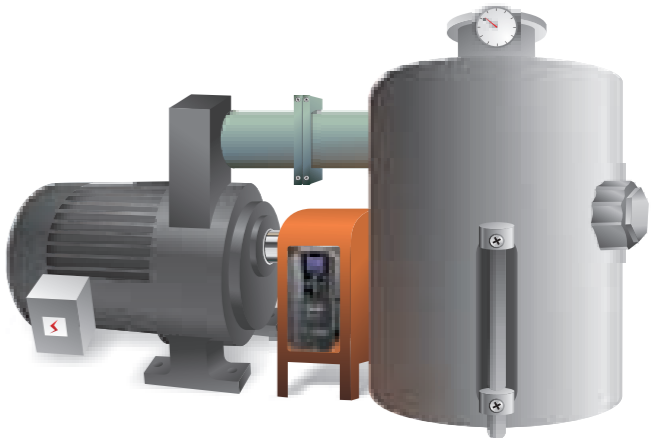

VFD-C

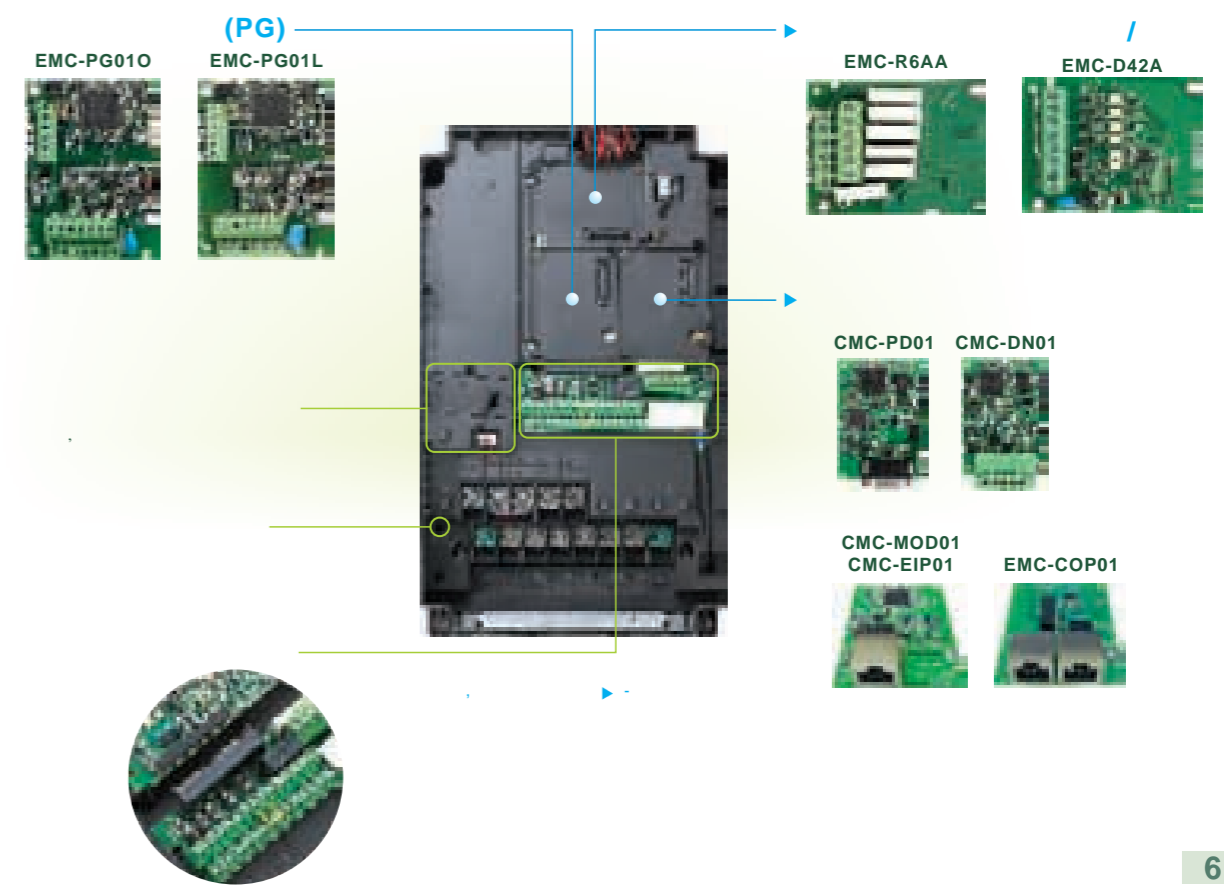
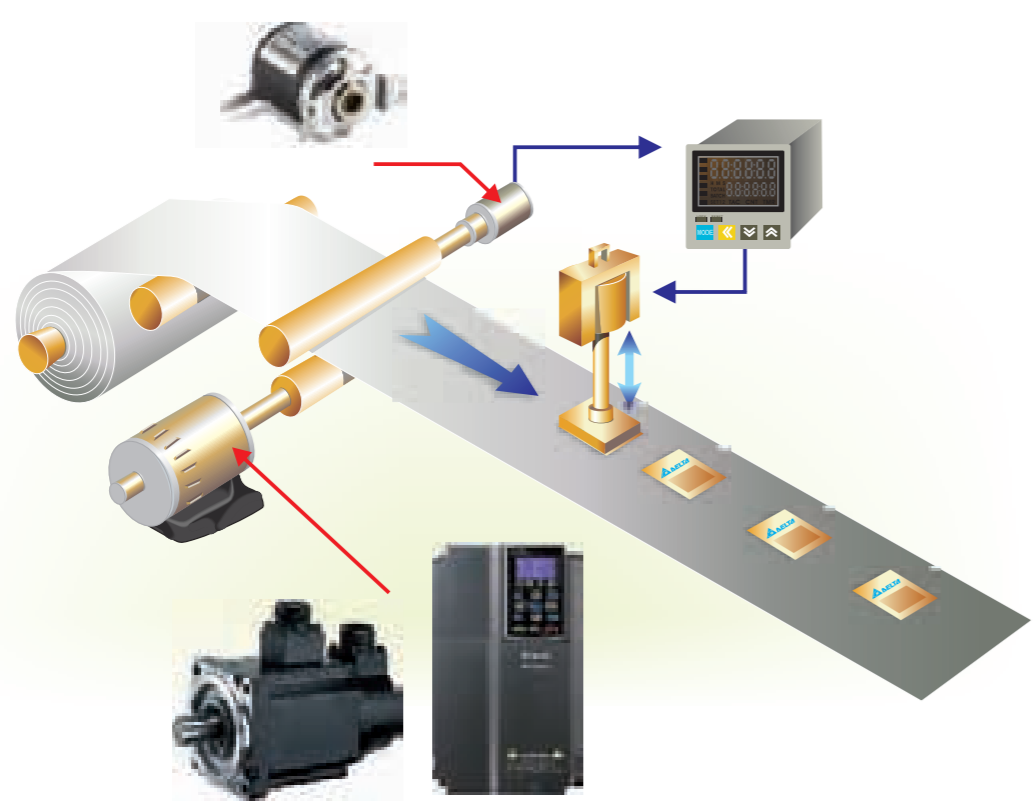

VFD-C2000

2- -1



RS-485



CANopen (DS402),

Delta

CANopen Builder,  
CANopen.

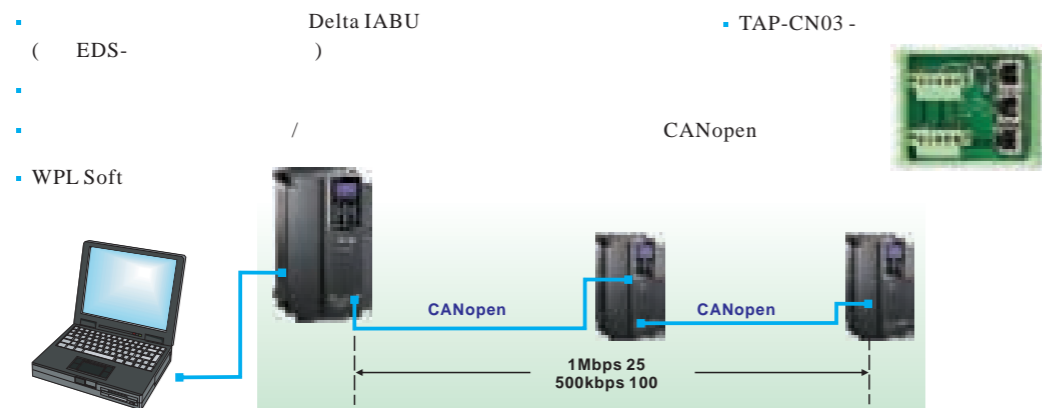

Delta DeviceNet Builder

DeviceNet



MODBUS TCP

DCI Soft



Ethernet



COM-

RFI-  
IEC/EN61000-3-2, 61000-3-12 61800-3.



- (1)
- (2)

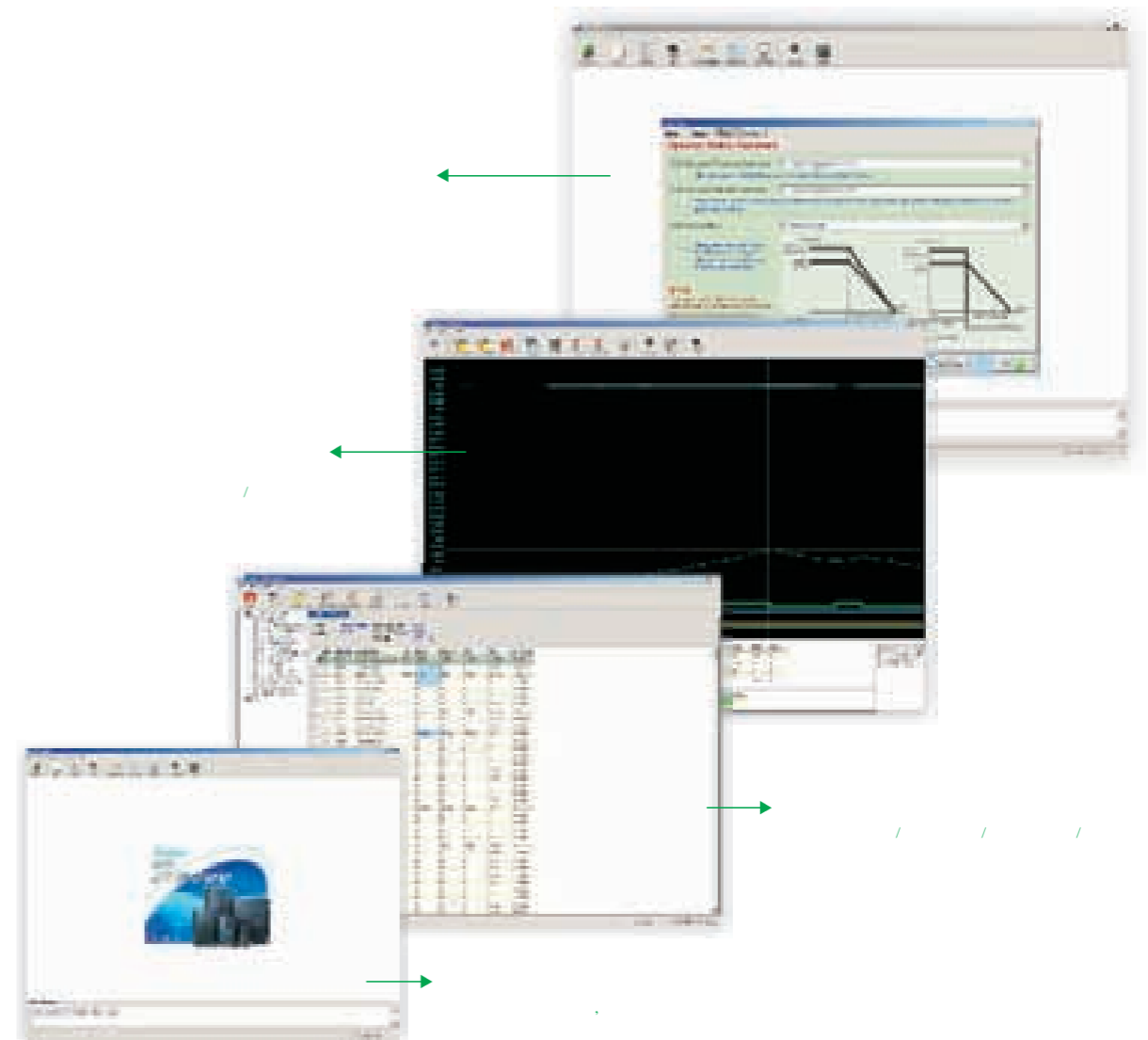

	<b>230 :</b> 0.75~3.7 (1~5HP)	VFD007C23A/E VFD037C23A/E VFD007C43A/E VFD015C43A/E VFD037C43A/E VFD040C43A/E VFD055C43A/E	[MKC-AFM]
	<b>460 :</b> 0.75~5.5 (1~7.5HP)	VFD015C23A/E VFD022C23A/E VFD022C43A/E	[MKC-AFM1]
	<b>230 :</b> 5.5~11 (7.5~15HP)	VFD055C23A/E VFD075C23A/E VFD110C23A/E VFD075C43A/E VFD110C43A/E VFD150C43A/E	[MKC-BFM]
	<b>460 :</b> 7.5~15 (10~20HP)		
	<b>230 :</b> 15~22 (20~30HP)	VFD150C23A/E VFD185C23A/E VFD220C23A/E VFD185C43A/E VFD220C43A/E VFD300C43A/E	[MKC-CFM]
	<b>460 :</b> 18.5~30 (25~40HP)		
	<b>230 :</b> 30~37 (40~50HP)	VFD300C23A VFD370C23A VFD370C43A VFD450C43A VFD550C43A VFD750C43A VFD300C23E VFD370C23E VFD370C43E VFD450C43E VFD550C43E VFD750C43E	▶ Conduit box kit [MKC-DN1CB]
	<b>460 :</b> 37~75 (50~100HP)		
	<b>230 :</b> 45~75 (60~100HP)	VFD450C23A/E VFD550C23A/E VFD750C23A VFD900C43A/E VFD1100C43A/E VFD750C23E	▶ Conduit box kit [MKC-EN1CB]
	<b>460 :</b> 90~110 (125~150HP)		
	<b>230 :</b> 90 (125HP)	VFD900C23A/E VFD1320C43A/E VFD1600C43A/E	2010 . II .
	<b>460 :</b> 132~160 (175~215HP)		
	<b>460 :</b> 185~220 (250~300HP)	VFD1850C43A/E VFD2200C43A/E	2010 . II .
	<b>460 :</b> 280~355 (375~475HP)	VFD2800C43A/E VFD3150C43A/E VFD3550C43A/E	2010 . II .

MODEL: VFD007C43A

INPUT:  
Normal Duty: 3PH 380-480V 50/60Hz 4.3A  
Heavy Duty: 3PH 380-480V 50/60Hz 4.1A

OUTPUT:  
Normal Duty: 3PH 0-480V 3A 2.4KVA 1HP  
Heavy Duty: 3PH 0-480V 2.9A 2.3KVA 1HP

FREQUENCY RANGE:  
Normal Duty: 0-600Hz  
Heavy Duty: 0-300Hz





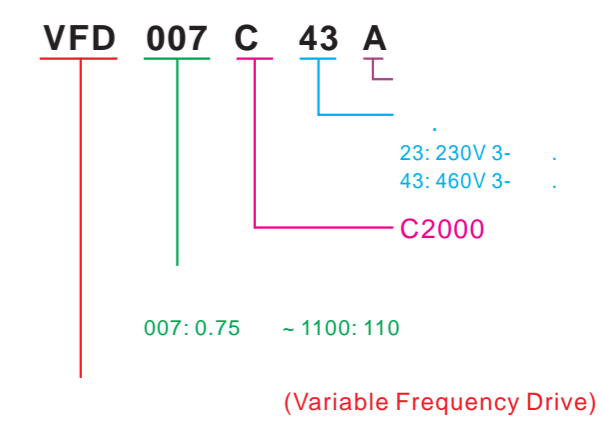

Version: VX.XX

(IPXX)

007C43A7T9300002

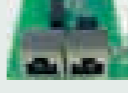
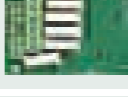
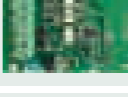
DELTA ELECTRONICS, INC.  
MADE IN XXXXXXX



	CMC-EIP01 CMC-MOD01		EtherNet/IP (CMC-EIP01) MODBUS TCP (CMC-MOD01) 10/100 / ,
	CMC-PD01		DP-PROFIBUS 9.6 / , 19.2 / , 96.75 / , 187.5 / , 500 / , 1.5 / , 3 / , 6 / 12 /
	CMC-DN01		DeviceNet 125 / , 250 / , 500 /
	EMC-COP01		CANopen 1 500k 250k 125k 100k 50k
	EMC-R6AA		(6 )
	EMC-D42A		(4 2 / )
(PG)	EMC-PG01O		PG : V+ ( , PLC ) : 300
	EMC-PG01L		PG : : 5VDC : 50 : 300
	KPC-CE01		7- LED- , (MKC-KPPK) , IP56.

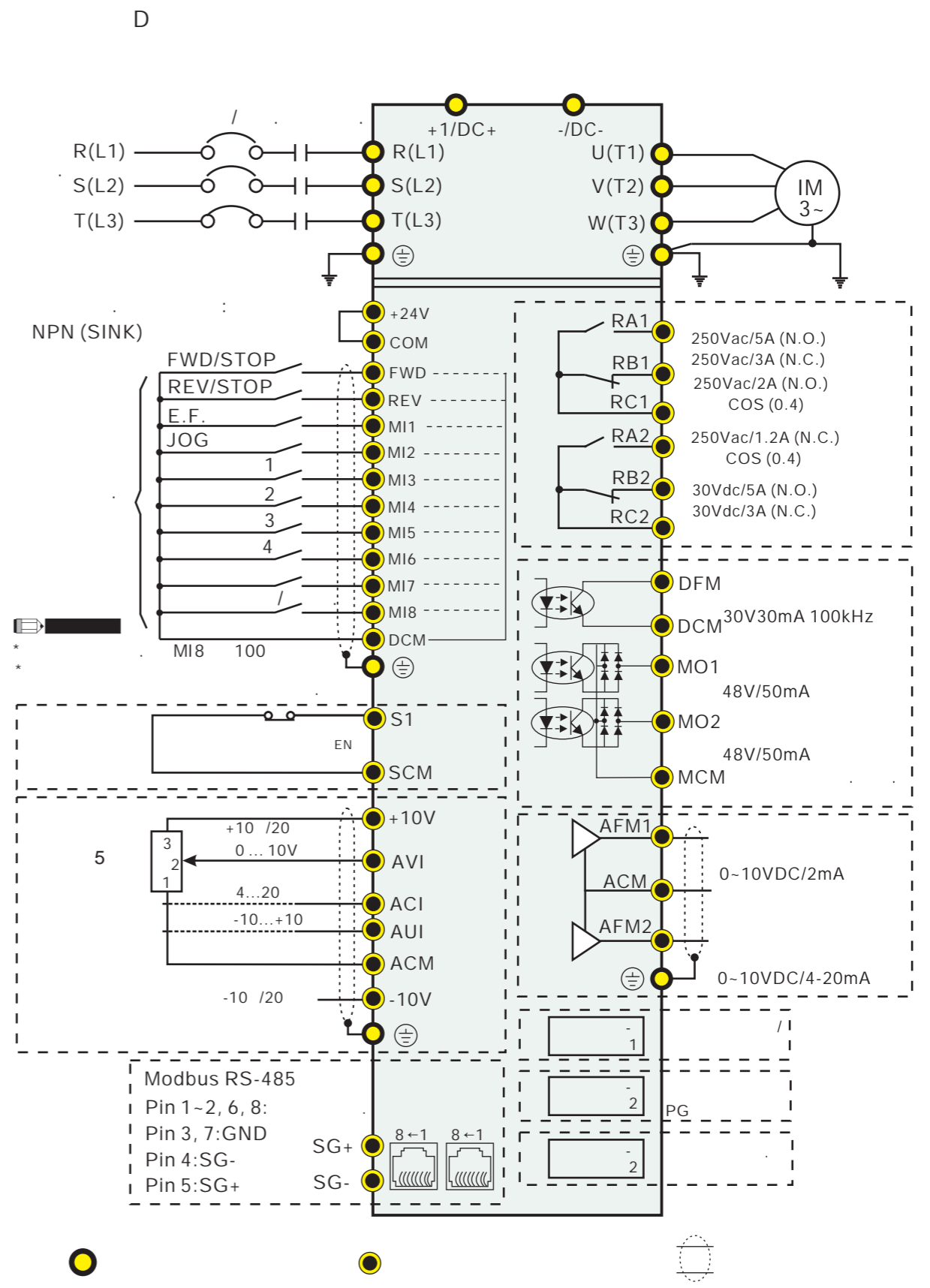
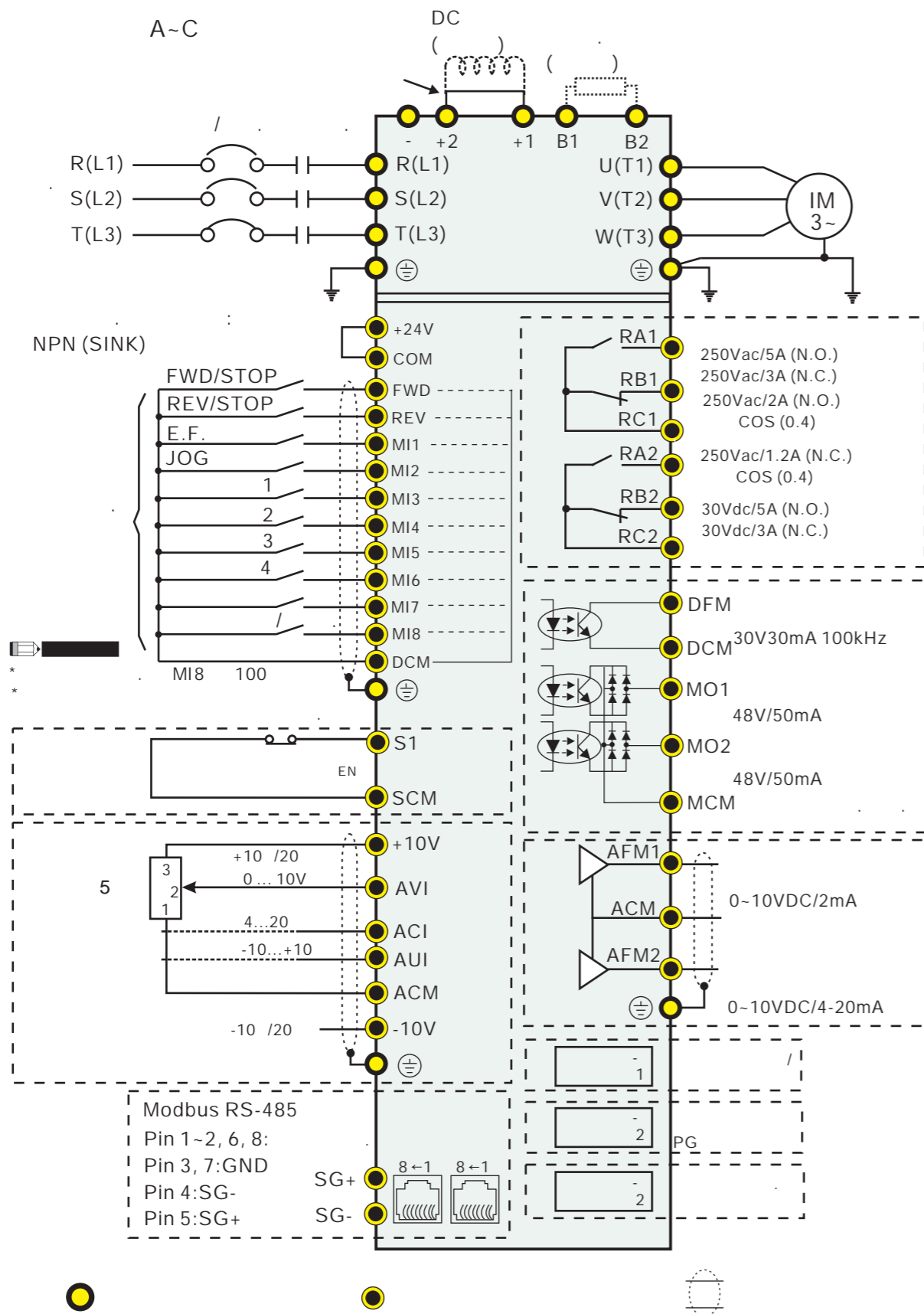

230V		A				B				C				D		E	
VFD-__C__		007	015	022	037	055	075	110	150	185	220	300	370	450	550	750	
( )		0.75	1.5	2.2	3.7	5.5	7.5	11	15	18.5	22	30	37	45	55	75	
(..)		1	2	3	5	7.5	10	15	20	25	30	40	50	60	75	100	
( )		1.9	2.8	4.0	6.4	9.6	12	19	25	28	34	45	55	68	81	96	
(A)		4.8	7.1	10	16	24	31	47	62	71	86	114	139	171	204	242	
( )		2-6															
( )		2.0	3.2	4.4	6.8	10	13	20	26	30	36	48	58	72	86	102	
(A)		5	8	11	17	25	33	49	65	75	90	120	146	180	215	255	
( )		2-15					2-10					2-9					
(A)		6.1	11	15	18.5	26	34	50	68	78	95	118	136	162	196	233	
(A)		6.4	12	16	20	28	36	52	72	83	99	124	143	171	206	245	
/		3- AC 200 (-15%)...240 (+10%), 50/60															
		170-265Vac															
		47-63															
EMI-																	

1: V/F, 2: SVC, 3: VF+PG, 4: FOC+PG	150%	0.5	150%	0	1
V/f	4				
5 ( )	40				
.200%					
±5%					
( )	:0.01~600.00		:0.00~300.00		
	:±0.01%, -10...+40°		:±0.1%, 25±10°		
	:0.01		:0.03/60 (±11)		
	:120%		1		
	:150%		1		
/	+10...-10, 0...10, 4...20, 0...20				
J	0.00...600.00/0.0...6000.0				
	MODBUS (RS-485 (RJ45)) 115.2 / ,				
	B : / ;		C :		
	: 240%		: 170~175%;		: 180~185%
230:	DC		410		
460:	DC		820		
	20				
	: 50%				

460V		A					B					C					D					E				
VFD-__C__		007	015	022	037	040	055	075	110	150	185	220	300	370	450	550	750	900	1100							
( )		0.75	1.5	2.2	3.7	4.0	5.5	7.5	11	15	18.5	22	30	37	45	55	75	90	110							
(..)		1	2	3	5	5	7.5	10	15	20	25	30	40	50	60	75	100	125	150							
( )		2.3	3.0	4.5	6.5	7.6	9.6	14	18	24	29	34	45	55	69	84	114	136	167							
(A)		2.9	3.8	5.7	8.1	9.5	11	17	23	30	36	43	57	69	86	105	143	171	209							
( )		2-6																								
( )		2.4	3.2	4.8	7.2	8.4	10	14	19	25	30	36	48	58	73	88	120	143	175							
(A)		3.0	4.0	6.0	9.0	10.5	12	18	24	32	38	45	60	73	91	110	150	180	220							
( )		2-15					2-10					2-9														
(A)		4.1	5.6	8.3	13	14.5	16	19	25	33	38	45	60	70	96	108	149	159	197							
(A)		4.3	5.9	8.7	14	15.5	17	20	26	35	40	47	63	74	101	114	157	167	207							
/		3- AC 38 (-15%)...480 (+10%), 50/60																								
		323~528Vac																								
		47-63																								
EMI-		VFDXXXC43A: EMI-					EMI-					VFDXXXC43A:					con du it box kit; VFDXXX43E: NEMA1									

0.01 / 2	
IEC60364-1/IEC60664-1	2,
NEMA 1/UL Type 1	2% 1° : -10...+40°
UL Open Type	2% 1° : -10...+50°
/	-25...+70°
	.90%
/	.95%
/	86...106
	70...106
IEC60721-3-3 (application is in progress)	
	Class 3C2; Class 3S2
	Class 2C2; Class 2S2
	Class 1C2; Class 1S2
	1000 2% 0.5°C 1000...3000 100
/	ISTA procedure 1A( ) IEC60068-2-31
1.5	, 3-13 , 1G 13-200 ( IEC 60068-2-6)
15G	11 ( IEC/EN 60068 2-27)
	±10°



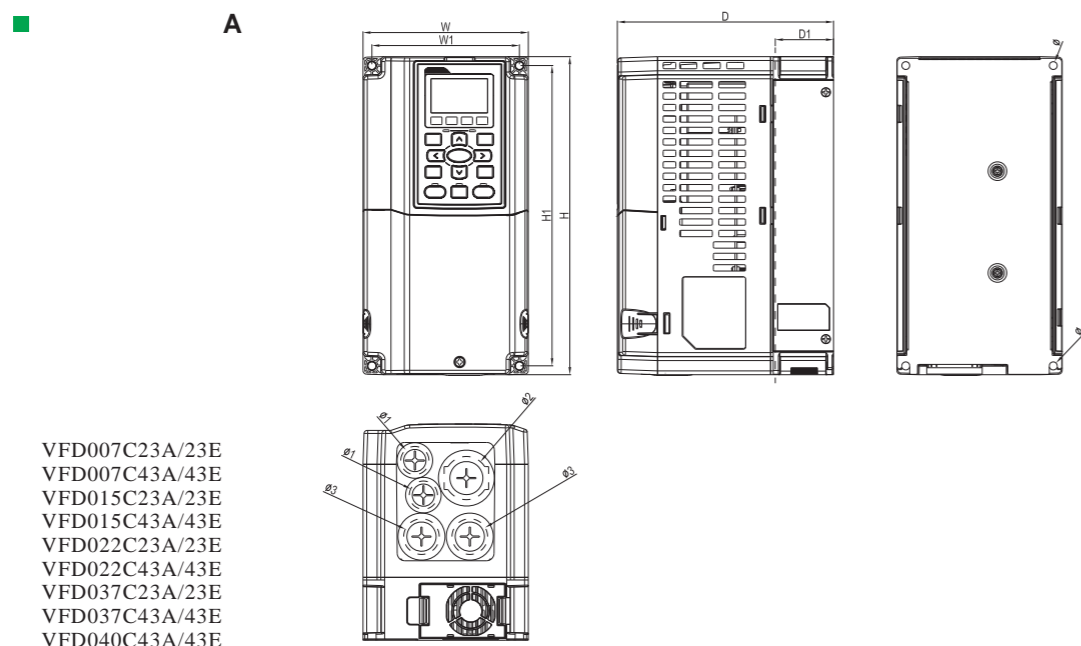

VFD007C23A/23E  
 VFD007C43A/43E  
 VFD015C23A/23E  
 VFD015C43A/43E  
 VFD022C23A/23E  
 VFD022C43A/43E  
 VFD037C23A/23E  
 VFD037C43A/43E  
 VFD040C43A/43E  
 VFD055C43A/43E

	W	H	D	W1	H1	D1*	Ø	Ø1	Ø2	Ø3
A	130.0	250.0	170.0	116.0	236.0	45.8	6.2	22.2	34.0	28.0
	5.12	9.84	6.69	4.57	9.29	1.80	0.24	0.87	1.34	1.10

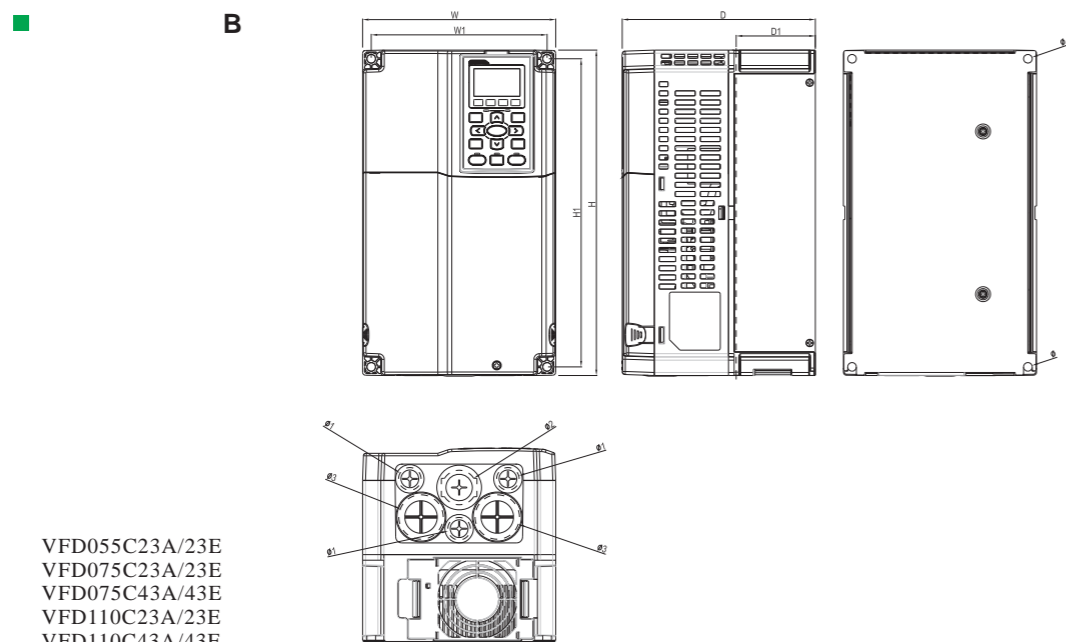

VFD055C23A/23E  
 VFD075C23A/23E  
 VFD075C43A/43E  
 VFD110C23A/23E  
 VFD110C43A/43E  
 VFD150C43A/43E

	W	H	D	W1	H1	D1*	Ø	Ø1	Ø2	Ø3
B	190.0	320.0	190.0	173.0	303.0	77.9	8.5	22.2	34.0	43.8
	7.48	12.60	7.48	6.81	11.93	3.07	0.33	0.87	1.34	1.72

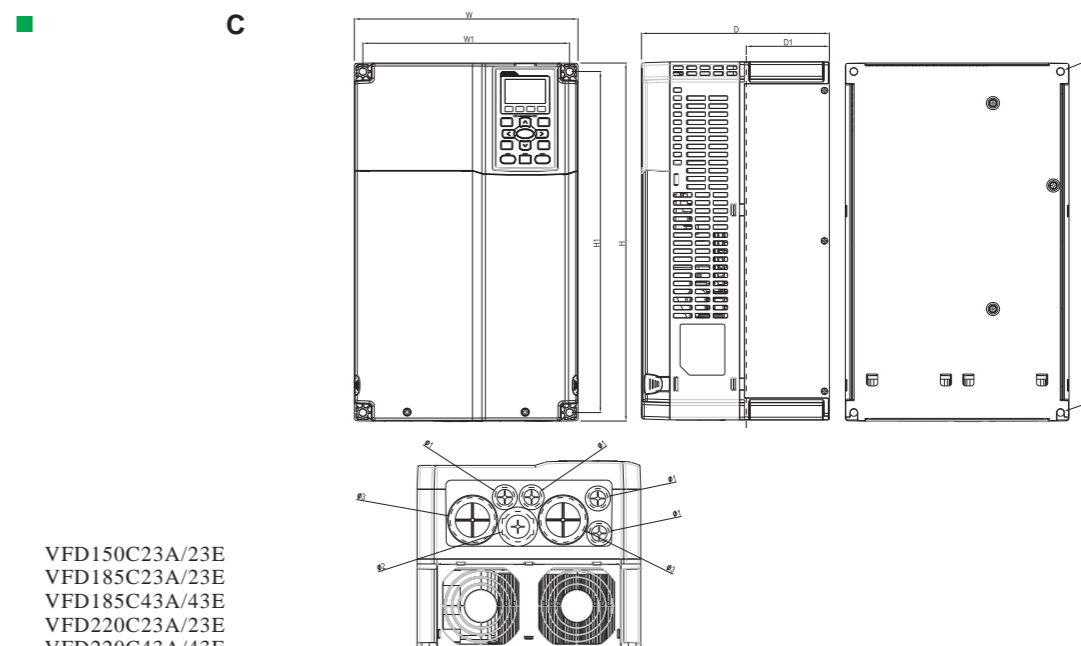

VFD150C23A/23E  
 VFD185C23A/23E  
 VFD185C43A/43E  
 VFD220C23A/23E  
 VFD220C43A/43E  
 VFD300C43A/43E

	W	H	D	W1	H1	D1*	Ø	Ø1	Ø2	Ø3
C	250.0	400.0	210.0	231.0	381.0	92.9	8.5	22.2	34.0	50.0
	9.84	15.75	8.27	9.09	15.00	3.66	0.33	0.87	1.34	1.97

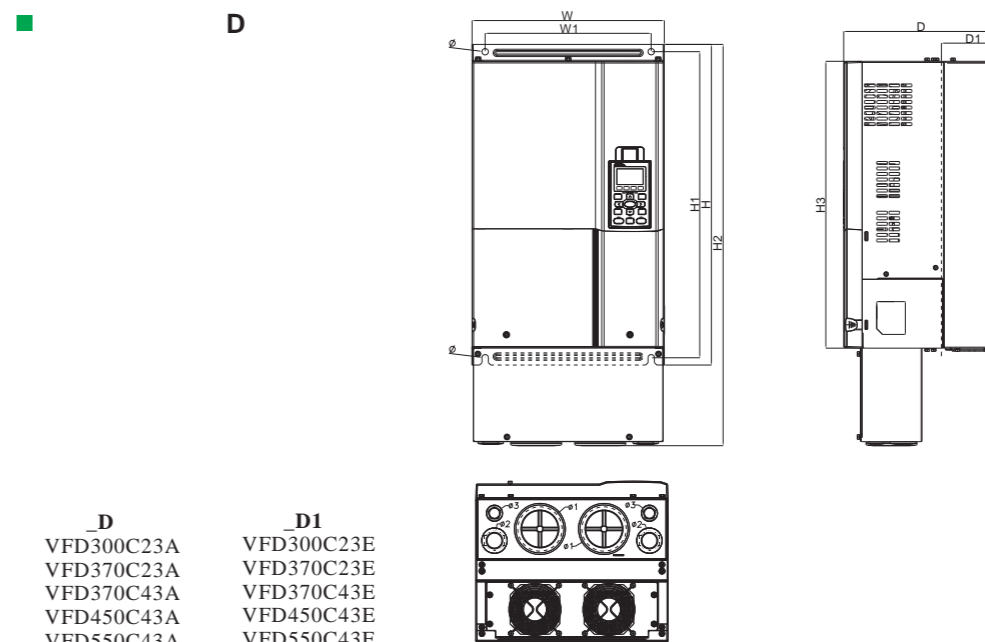

**\_D**  
 VFD300C23A  
 VFD370C23A  
 VFD370C43A  
 VFD450C43A  
 VFD550C43A  
 VFD750C43A

**\_D1**  
 VFD300C23E  
 VFD370C23E  
 VFD370C43E  
 VFD450C43E  
 VFD550C43E  
 VFD750C43E

	W	H	D	W1	H1	H2	H3	D1*	Ø	Ø1	Ø2	Ø3
D	330.0 [12.99]	550.0 [21.65]	275.0 [10.83]	285.0 [11.22]	525.0 [20.67]	-	492.0 [19.37]	107.2 [4.22]	11.0 [0.43]	34.0 [1.34]	22.0 [0.87]	11.0 [0.43]
D1	330.0 [12.99]	550.0 [21.65]	275.0 [10.83]	285.0 [11.22]	525.0 [20.67]	688.3 [27.10]	492.0 [19.37]	107.2 [4.22]	11.0 [0.43]	34.0 [1.34]	22.0 [0.87]	11.0 [0.43]

E

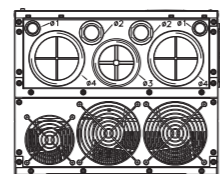
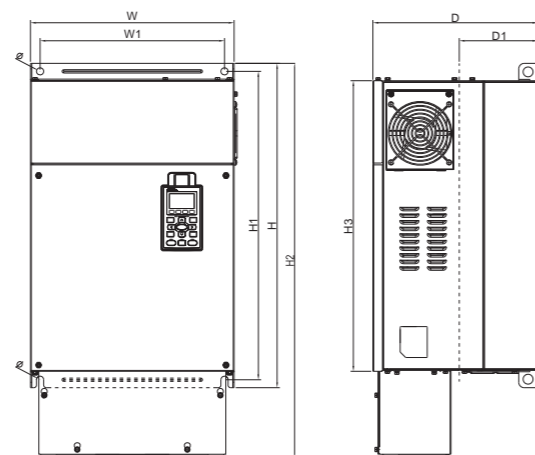

- |             |             |
|-------------|-------------|
| <b>_E</b>   | <b>_E1</b>  |
| VFD450C23A  | VFD450C23E  |
| VFD550C23A  | VFD550C23E  |
| VFD900C43A  | VFD900C43E  |
| VFD1100C43A | VFD1100C43E |

	W	H	D	W1	H1	H2	H3	D1*	Ø	Ø1	Ø2	Ø3	Ø4
<b>E</b>	370.0 [14.57]	589.0 [23.19]	300.0 [11.81]	335.0 [13.19]	560.0 [22.05]	-	528.0 [20.80]	143.0 [5.63]	13.0 [0.51]	22.0 [0.87]	34.0 [1.34]	76.0 [2.99]	92.0 [3.62]
<b>E1</b>	370.0 [14.57]	589.0 [23.19]	300.0 [11.81]	335.0 [13.19]	560.0 [22.05]	715.8 [28.18]	528.0 [20.80]	143.0 [5.63]	13.0 [0.51]	22.0 [0.87]	34.0 [1.34]	76.0 [2.99]	92.0 [3.62]

E1\*:

