

TCC-80/80I Series

Port-powered RS-232 to RS-422/485 converters with optional 2.5 KV isolation



- > External power source supported but not required
- > Compact size
- > Converts RS-422, and both 2-wire and 4-wire RS-485
- > RS-485 automatic data direction control
- > Automatic baudrate detection
- > 15 KV serial ESD protection
- > Built-in 120-ohm termination resistors
- > 2.5 KV isolation (for TCC-80I only)
- > LED port power indicator



Introduction

The TCC-80/80I media converters provide complete signal conversion between RS-232 and RS-422/485, without requiring an external power source. The converters support both half duplex 2-wire RS-485 and full duplex 4-wire RS-422/485, either of which can be converted between RS-232's TxD and RxD lines. In addition, the TCC-80/80I's 15 KV ESD protection guards against damage from electrostatic discharge, and the TCC-80I is the world's first high-speed, port-powered converter with 2.5 KV isolation.

Automatic data direction control is provided for RS-485. In this case, the RS-485 driver is enabled automatically when the circuitry senses the TxD output from the RS-232 signal. This means that no programming effort is required to control the transmission direction of the RS-485 signal. Moreover, the TCC-80I's patented LED port power indicator lets you check whether or not the TCC-80I is receiving enough power.

Port Power over RS-232

The RS-232 port of the TCC-80/80I is a DB9 female socket that can connect directly to the host PC, with power drawn from the TxD line. Regardless of whether the signal is high or low, the TCC-80/80I can obtain enough power from the data line. However, external power can be used if the handshake line is not available, if the serial cable is too long, or if the RS-232 device is a low power device. For external power, a 5 to 12 VDC power supply can be connected using an adaptor or a USB power cord.



External Power Adaptor

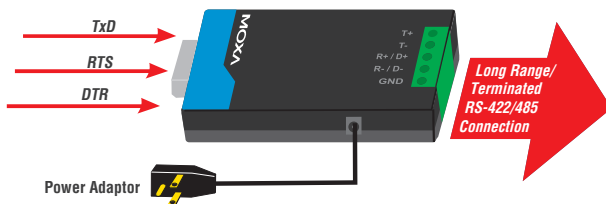

USB Power

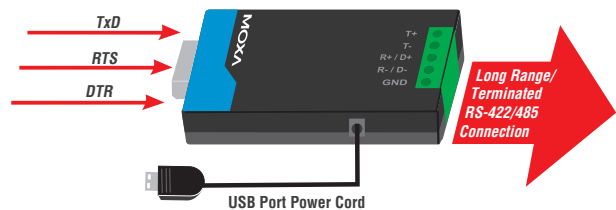

Port Power Dissipation

When installing a TCC-80 or TCC-80I converter, it is important to pay attention to power consumption, RS-232 cable length, and RS-422/485 transmission distance. In general, the TCC-80 and TCC-80I obtain 50 mW of power from the power source. Standard PC COM ports can provide 70 to 90 mW of power if the TxD, RTS, and DTR

lines are connected. Moreover, the RS-232 cable should be shorter than 15 m (@ 9600 bps) to ensure that less power is lost from the host/device to the TCC-80. The remainder of the supplied power is used for transmitting the RS-422/485 signal.

Port Power and Optical Isolation

The RS-232 port of the TCC-80/80I is a DB9 female socket that can connect directly to the host PC, with power drawn from the TxD line. Electrical 2.5 KV isolation for the TCC-80I is achieved with a photo coupler that transforms the electrical signal into light, and then re-transforms the light back into an electrical signal on the other side. In this way, the two electrical circuits are completely isolated from each other. This also protects the devices from ground loop currents, reduces damage caused by data loss, and prevents damage to the communication interfaces.

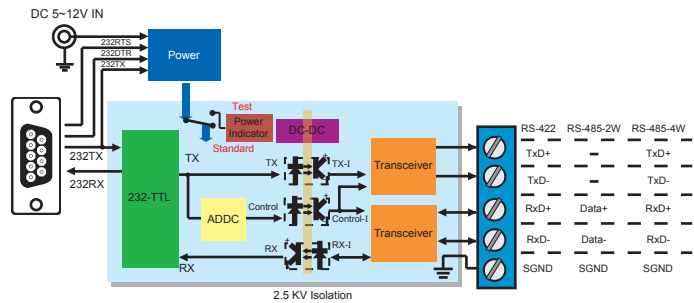

LED Port Power Indicator

It's easy enough to test the serial device with a multimeter to determine that the serial device will provide enough power to the media converter. However, it's even easier to let the TCC-80I test the device for you. Simply connect the TCC-80I to the device's RS-232 port and set the SW4 switch to Test mode. If the patented port power LED indicator lights up, the TCC-80I is receiving enough power. If the LED does not light up, you will need to attach an external power source to the TCC-80I.

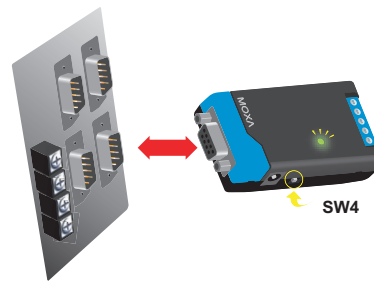

Specifications

RS-232 Side

Connector: DB9 female

Signals:

RS-232: TxD, RxD, GND

(Loop-back wiring: RTS to CTS, DTR to DSR and DCD)

RS-422/485 Side

Connector: Terminal Block or DB9 male

Signals:

(interface selected by DIP switch)

RS-422: TxD+, TxD-, RxD+, RxD-, GND

RS-485-4w: TxD+, TxD-, RxD+, RxD-, GND

RS-485-2w: Data+, Data-, GND

RS-485 Data Direction Control: ADDC® (automatic data direction control)

Serial Communication

Baudrate: 50 bps to 115.2 Kbps

ESD Protection: 15 KV

Optical Isolation: 2.5 KV rms for 1 minute (TCC-80I only)

Physical Characteristics

Housing: ABS + PC

Dimensions:

TCC-80/80I: 42 x 80 x 22 mm (1.65 x 3.15 x 0.87 in)

TCC-80-DB9/80I-DB9: 42 x 91 x 23.6 mm (1.65 x 3.58 x 0.93 in)

Weight: 50 ± 5 g

Environmental Limits

Operating Temperature: 0 to 60°C (32 to 140°F)

Storage Temperature: -20 to 75°C (-4 to 167°F)

Ambient Relative Humidity: 5 to 95% (non-condensing)

Power Requirements

Source of Input Power: RS-232 port (TxD, RTS, DTR) or power input jack

Input Voltage: 5 to 12 VDC

Power Consumption:

TCC-80: 10 mA @ 5 V (with termination disabled)

TCC-80I: 20 mA @ 5 V (with termination disabled)

Standards and Certifications

Safety: UL 60950-1

EMC: CE, FCC

EMI: FCC Part 15 Subpart B Class B

EMS:

EN 61000-4-2 (ESD) Level 2,

EN 61000-4-3 (RS) Level 2,

EN 61000-4-4 (EFT) Level 2,

EN 61000-4-5 (Surge) Level 3,

EN 61000-4-6 (CS) Level 2,

EN 61000-4-8 (SFMF) Level 1

Green Product: RoHS, CRoHS, WEEE

MTBF (mean time between failures)

Time: 2,781,161 hrs

Database: Telcordia (Bellcore), GB

Warranty

Warranty Period: 5 years

Details: See www.moxa.com/warranty

Dimensions

Unit: mm (inch)

TCC-80

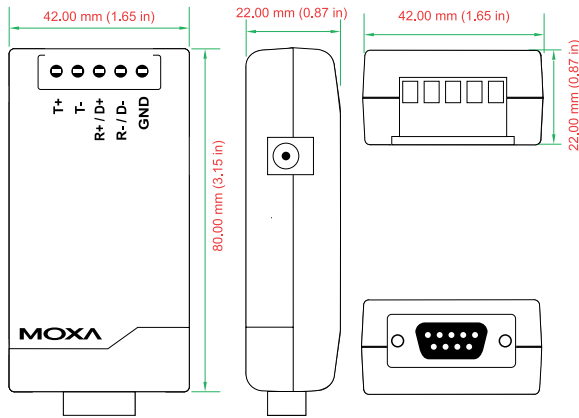

TCC-80I

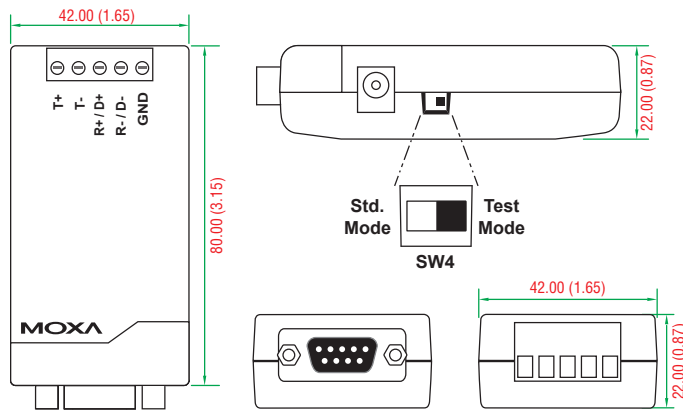

TCC-80-DB9, TCC-80I-DB9

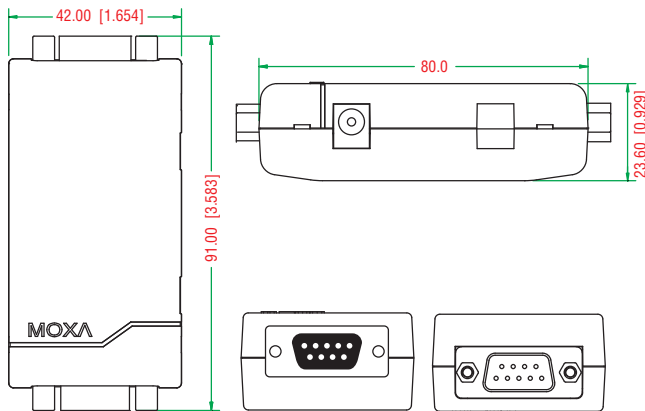

DB9 female connector

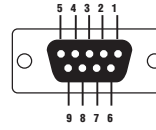

PIN	RS-232
1	DCD
2	TxD
3	RxD
4	DSR
5	GND
6	DTR
7	CTS
8	RTS

DIP Switch Settings



DIP Switch Settings			
RS-422 with Terminator	SW1	SW2	SW3
	OFF	OFF	ON
RS-422	SW1	SW2	SW3
	OFF	OFF	OFF
4-wire RS-485 with Terminator	SW1	SW2	SW3
	ON	OFF	ON
4-wire RS-485	SW1	SW2	SW3
	ON	OFF	OFF
2-wire RS-485 with Terminator	SW1	SW2	SW3
	ON	ON	ON
2-wire RS-485	SW1	SW2	SW3
	ON	ON	OFF

DB9 male RS-422/485 port

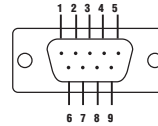

PIN	RS-422/RS-485-4w	RS-485-2w
1	TxD+(B)	-
2	TxD-(A)	-
3	RxD+(B)	Data+(B)
4	RxD-(A)	Data-(A)
5	GND	GND
6	-	-
7	-	-
8	-	-

Ordering Information

Available Models

TCC-80: Port-powered RS-232 to RS-422/485 converter with 15 KV serial ESD protection and terminal block on the RS-422/485 side

TCC-80-DB9: Port-powered RS-232 to RS-422/485 converter with 15 KV serial ESD protection and DB9 male connector on the RS-422/485 side

TCC-80I: Port-powered RS-232 to RS-422/485 converter with 15 KV serial ESD protection, terminal block on the RS-422/485 side, and 2.5 KV optical isolation

TCC-80I-DB9: Port-powered RS-232 to RS-422/485 converter with 15 KV serial ESD protection, DB9 male connector on the RS-422/485 side, and 2.5 KV optical isolation

Optional Accessories (can be purchased separately)

CBL-F9M9-20: DB9 male to DB9 female RS-232 cable (20 cm)

Power Adaptor: See Appendix A for details

Package Checklist

- 1 TCC-80 or TCC-80I media converter
- USB power cord (50 cm)
- Quick installation guide (printed)
- Warranty card